

ARCHITECTURAL PROFILES



FEATURES

The F50 series is our narrow Architectural Profile sports an aluminum body at 50mm wide. Ideal for commercial & residential spaces.

F50

MODEL	F50
DIMENSION	50mm
MOUNTING	Surface Mount/Suspension Mount/Wall Mount/Recessed Mount
STYLES	Regressed Anti-Glare/Regressed Arch
KELVINS	2700K*/3000K/3500K/4000K*/5000K*
LENGTHS	6" – 8"/Continuous Run*
LENS	Opal/Opal Dropped
LIGHT DIRECTIONS	Direct & Indirect
LUMEN PACKAGES	Standard 135LM/W@3500K / High 150LM/W@3500K*
VOLTAGE	120V-277V/347V*
DIMMING	0-10V/TRIAC/Tuneable White*/Lutron*/Dim To Warm*
FINISHES	Black/White/Aluminum/Customization* (Require RAL#)

CERTIFICATIONS



APPLICATIONS

SURFACE MOUNT

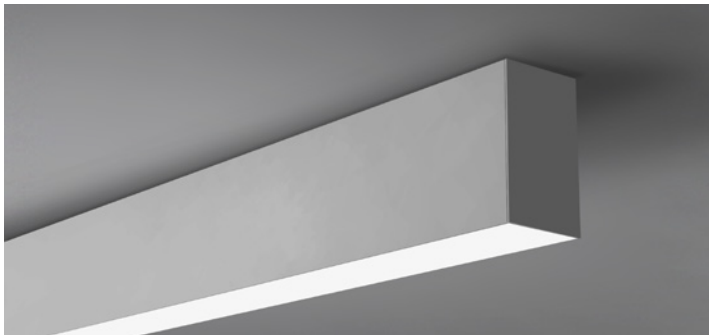

SUSPENSION MOUNT



RECESSED MOUNT

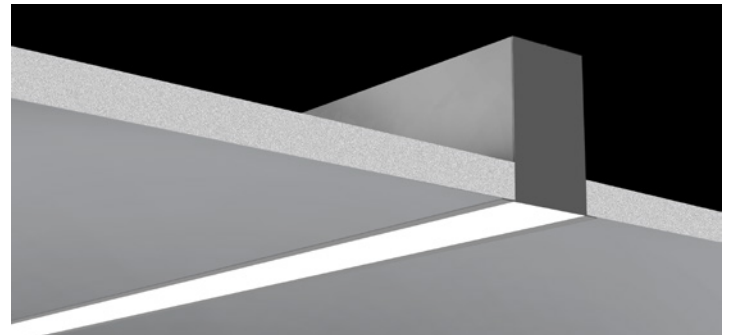

WALL MOUNT

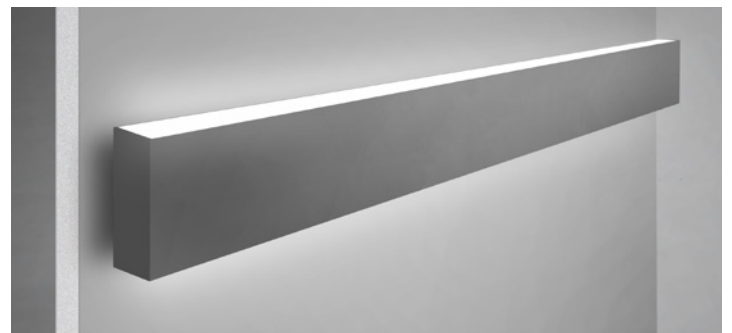

F50 SUSPENSION



MODEL F50	36104-017
DIMENSION	50mm x 75mm
MOUNTING	Suspension Mount
STYLE	Regressed Arch
KELVIN	2700K*/3000K/3500K/4000K*/5000K*
LENGTH	6" - 8'/Continuous Run*
LENS	Opal
LIGHT DIRECTION	Downlight
LUMEN PACKAGE	Standard 135LM/W@3500K / High 150LM/W@3500K*
VOLTAGE	120V-277V/347V*
DIMMING	0-10V/TRIAC/Tuneable White*/Lutron*/Dim To Warm*
FINISHES	Black/White/Aluminum/Customization* (Require RAL#)

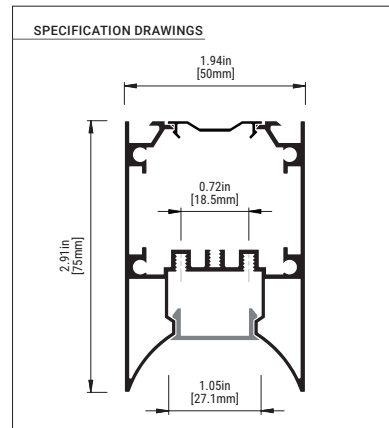

F50 SUSPENSION



MODEL F50	36134-014
DIMENSION	50mm x 107mm
MOUNTING	Suspension Mount
STYLE	Regressed Anti-Glare
KELVIN	2700K*/3000K/3500K/4000K*/5000K*
LENGTH	6" - 8'/Continuous Run*
LENS	Opal
LIGHT DIRECTION	Downlight
LUMEN PACKAGE	Standard 135LM/W@3500K / High 150LM/W@3500K*
VOLTAGE	120V-277V/347V*
DIMMING	0-10V/TRIAC/Tuneable White*/Lutron*/Dim To Warm*
FINISHES	Black/White/Aluminum/Customization* (Require RAL#)

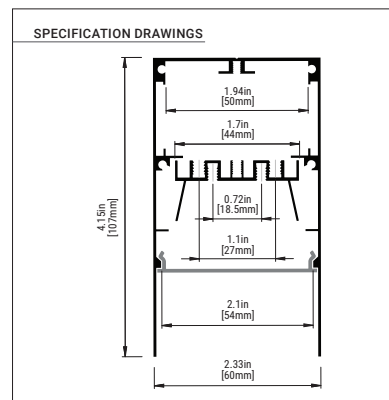

*PLEASE CONSULT FACTORY

F50 SUSPENSION



MODEL F50	36070-015
DIMENSION	50mm x 75mm
MOUNTING	Suspension Mount
KELVIN	2700K*/3000K/3500K/4000K*/5000K*
LENGTH	6" – 8'/Continuous Run*
LENS	Opal/Opal Dropped
LIGHT DIRECTION	Downlight
LUMEN PACKAGE	Standard 135LM/W@3500K / High 150LM/W@3500K*
VOLTAGE	120V-277V/347V*
DIMMING	0-10V/TRIAC/Tuneable White*/Lutron*/Dim To Warm*
FINISHES	Black/White/Aluminum/Customization* (Require RAL#)

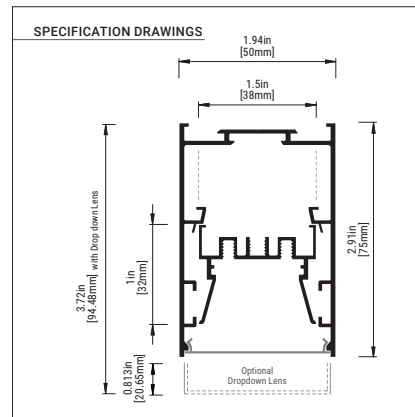

F50 SUSPENSION



MODEL F50	36121-014
DIMENSION	50mm x 120mm
MOUNTING	Suspension Mount
KELVIN	2700K*/3000K/3500K/4000K*/5000K*
LENGTH	6" – 8'/Continuous Run*
LENS	Opal
LIGHT DIRECTION	Up & Downlight
LUMEN PACKAGE	Standard 135LM/W@3500K / High 150LM/W@3500K*
VOLTAGE	120V-277V/347V*
DIMMING	0-10V/TRIAC/Tuneable White*/Lutron*/Dim To Warm*
FINISHES	Black/White/Aluminum/Customization* (Require RAL#)

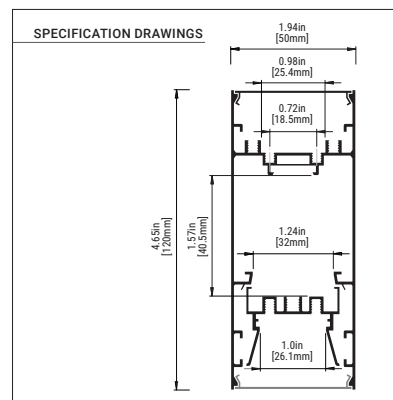

*PLEASE CONSULT FACTORY

F50 WALL MOUNT

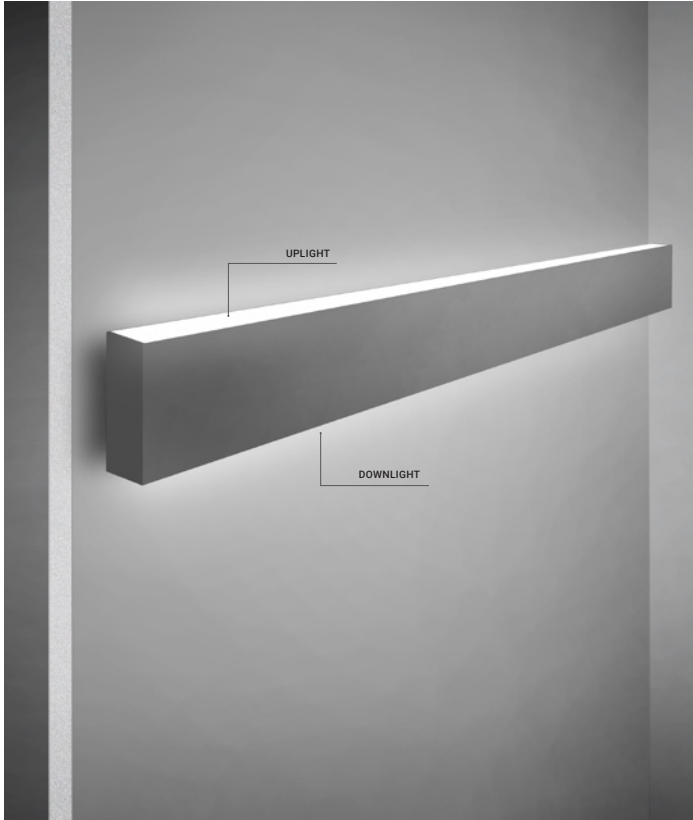

MODEL F50	36121-014
DIMENSION	50mm x 120mm
MOUNTING	Wall Mount
KELVIN	2700K*/3000K/3500K/4000K*/5000K*
LENGTH	6" – 8'/Continuous Run*
LENS	Opal
LIGHT DIRECTION	Up & Downlight
LUMEN PACKAGE	Standard 135LM/W@3500K / High 150LM/W@3500K*
VOLTAGE	120V-277V/347V*
DIMMING	0-10V/TRIAC/Tuneable White*/Lutron*/Dim To Warm*
FINISHES	Black/White/Aluminum/Customization* (Require RAL#)

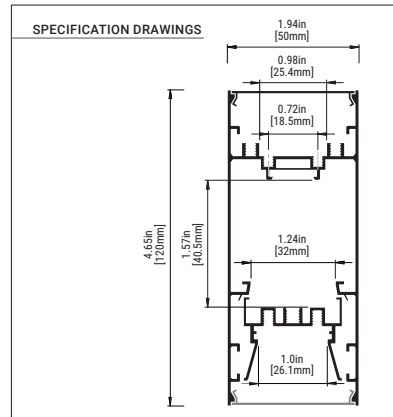

F50 RECESSED

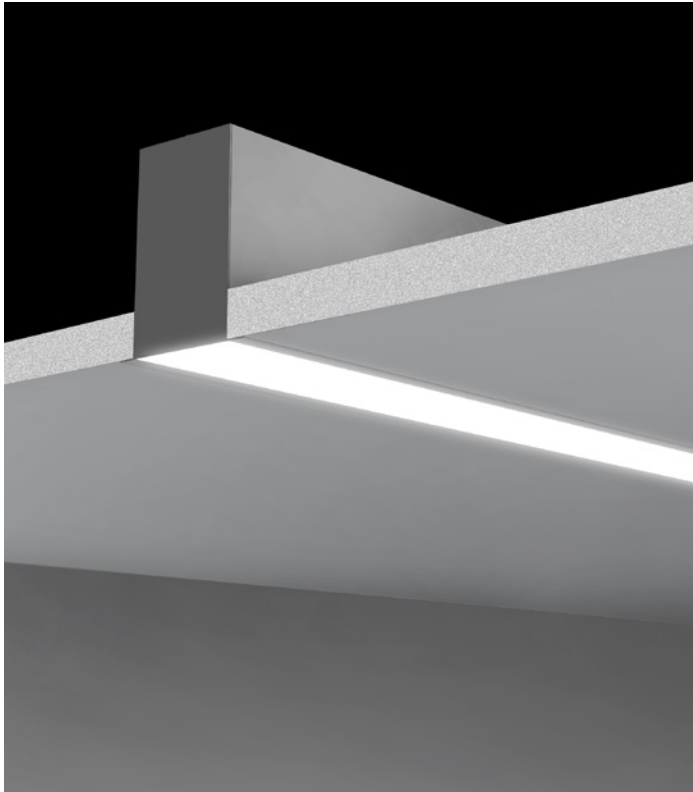

MODEL F50	36081-011
DIMENSION	50mm x 75mm
MOUNTING	Recessed Mount
KELVIN	2700K*/3000K/3500K/4000K*/5000K*
LENGTH	6" – 8'/Continuous Run*
LENS	Opal
LIGHT DIRECTION	Downlight
LUMEN PACKAGE	Standard 135LM/W@3500K / High 150LM/W@3500K*
VOLTAGE	120V-277V/347V*
DIMMING	0-10V/TRIAC/Tuneable White*/Lutron*/Dim To Warm*
FINISHES	Black/White/Aluminum/Customization* (Require RAL#)

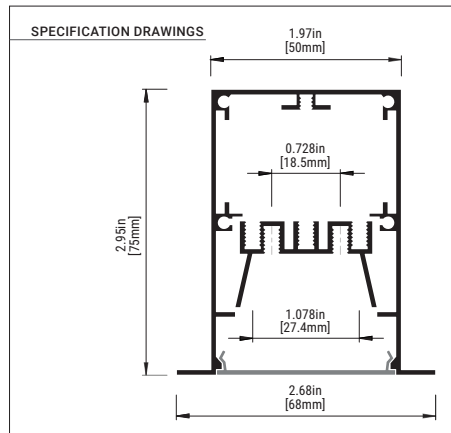

*PLEASE CONSULT FACTORY

ARCHITECTURAL PROFILES
LED Linear Lighting System

Fase¹

33 West Beaver Creek Road,
Richmond Hill, Ontario, Canada

DRIVER OPTIONS

OS1	1% Dimming (0-10V)
TRI	TRIAC Dimmable LED Driver
TW	Tuneable White (1500K-6500K)
HL1	Lutron HI-LUME 1% 2-wire LED Driver
ES	Lutron Digital Ecosystem
5ES	5 Series Ecosystem; 5% Dimming
DTW	Dim To Warm

SAMSUNG BOARD TECHNICAL SPECIFICATION

MODEL	Samsung Breakaway 44 inch
POWER CONSUMPTION	31W
LUMINOUS FLUX	Standard: 4185lm @ 3500K High: 4650lm @ 3500K
LUMINOUS EFFICACY	Standard: 135lm/W High: 150lm/W

WIRE FEED POSITIONS

APPLICATION: RECESSED, WALL MOUNT

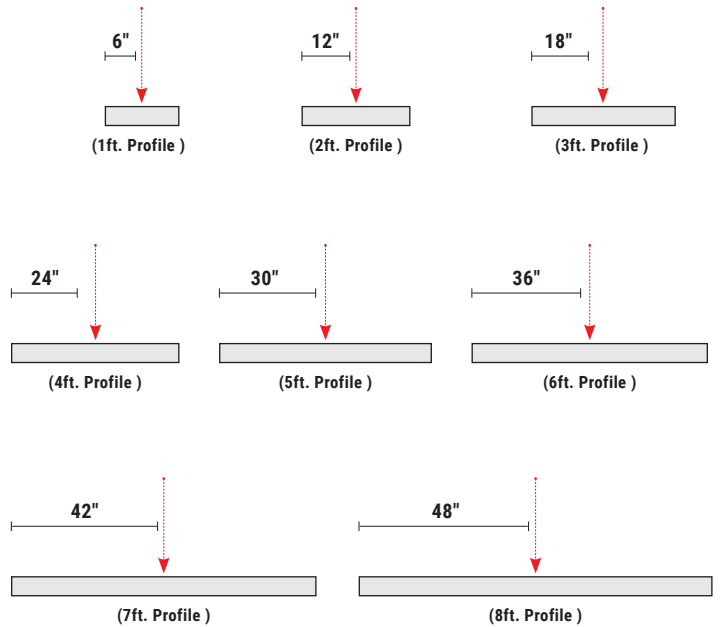

APPLICATION: SUSPENSION

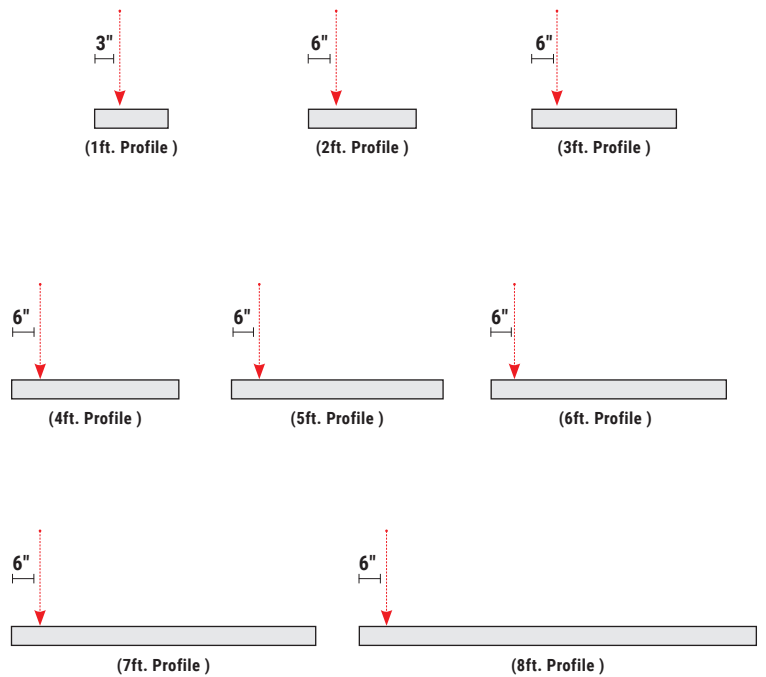

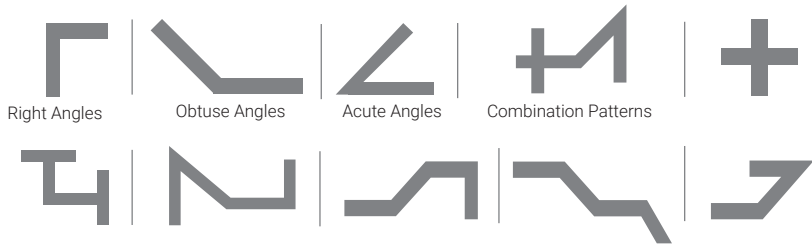

PATTERNS			
S - X	Square		
R - XY	Rectangle		
U - XYZ	U-Shape		
L - XY	L-Shape		
C	Custom Pattern		
Standard Patterns Minimal Lengths			
<p>Square</p>	<p>Rectangle</p>	<p>U-Shape</p>	<p>L-Shape</p>
<p>X = 23" min. Y = 23" min.</p>		<p>X = 23" min. Y = 23" min. Z = 23" min.</p>	<p>X = 23" min. Y = 23" min.</p>
Custom Patterns		Corner	
<p>"T"</p>		<p>"X"</p>	
		<p>All corners are mitre cut and customizable to any degree.</p>	

