

BRAVO

Fase¹

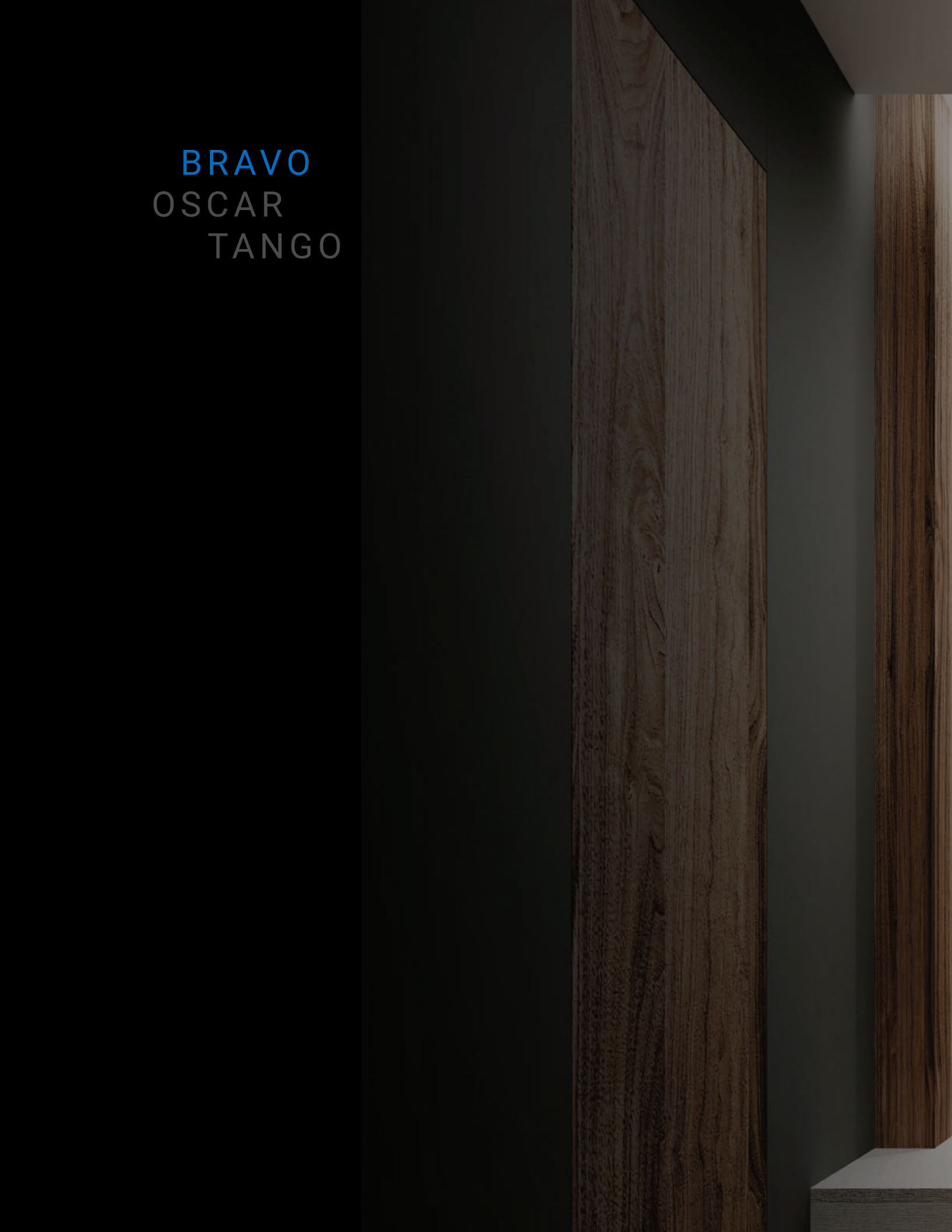

BRAVO
OSCAR
TANGO





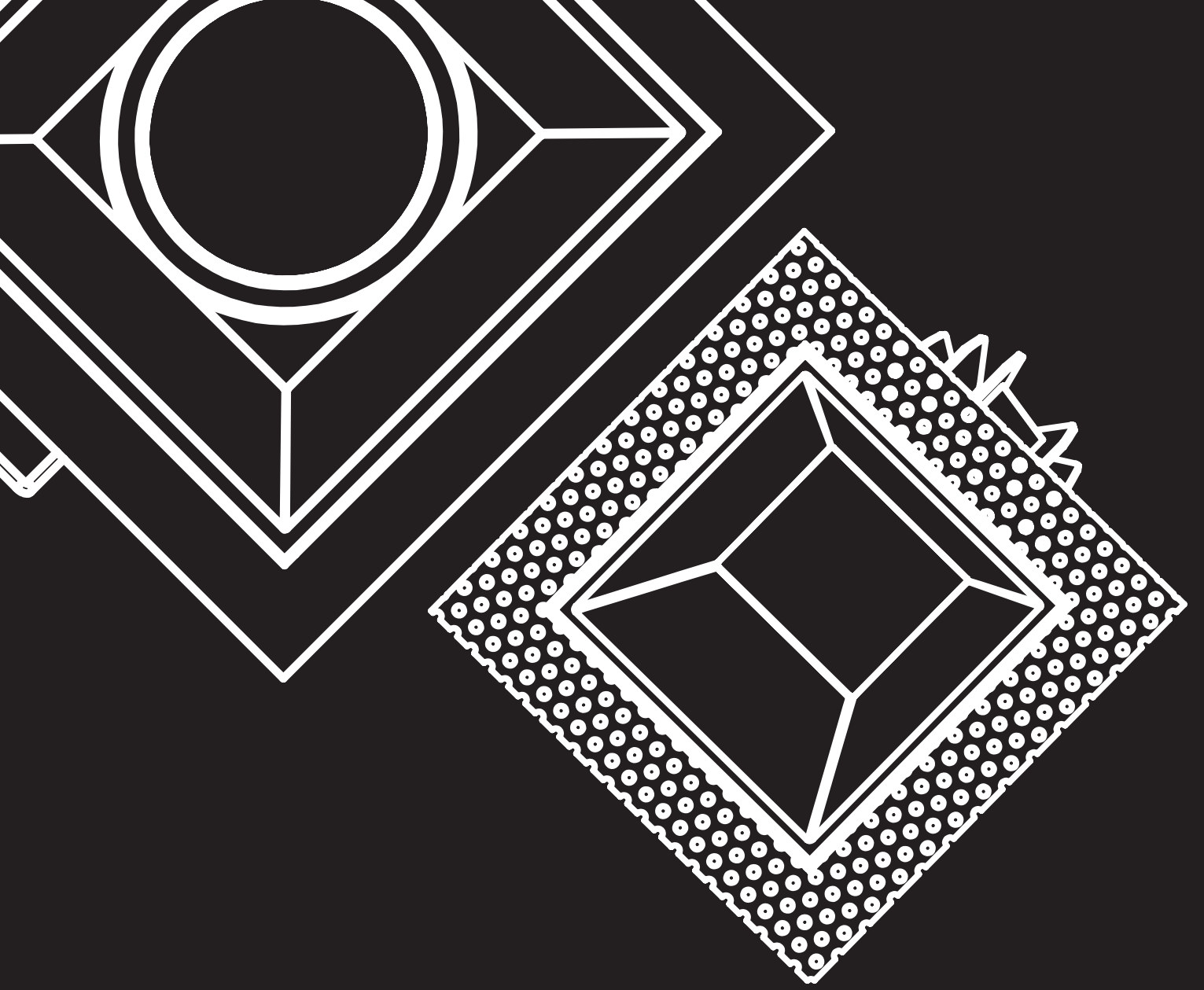

BR

AVO

Introducing

THE BRAVO

This squared, modular lighting system offers an extensive list of customization capabilities. With an arsenal of interchangeable accessories and modules, this collection features a super simple click connect for convenient modifying.

The Bravo collection, notably chic and elegant, exudes impeccable European class. Offering minimalistic recessed designs, this collection also features extremely economical surface mount housings in 1-, 2-, and 3-light options. Attract awe and adoration with the Bravo.

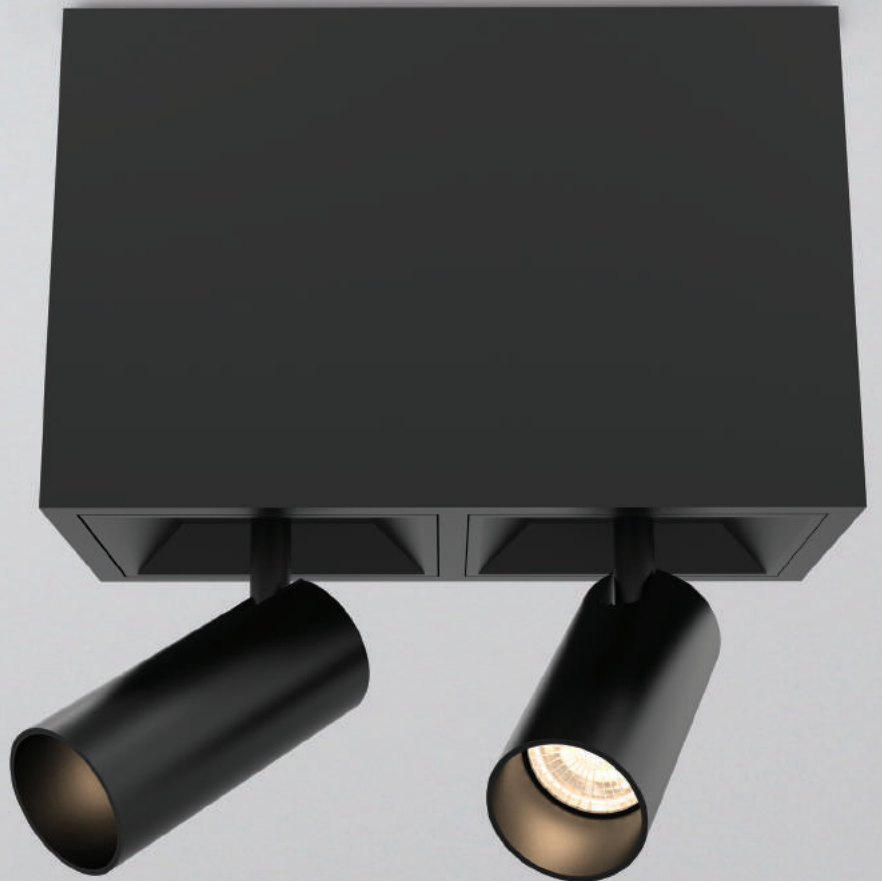

MOUNT STYLES

Bravo offers two mounting options for ease of installation with sleek style. The first is recessed with a classic subtle aesthetic that works with this modular system for a wide range of illumination options.

The second option, a widely anticipated surface mount, provides exemplary style without breaking the bank. This modern take will elevate your space without having to impose invasive installation practices.





LIGHT CHOICE

Each Bravo module sports a machined aluminum body that makes this versatile collection extremely durable. Built to last, choose between seven different light modules to meet your every need.

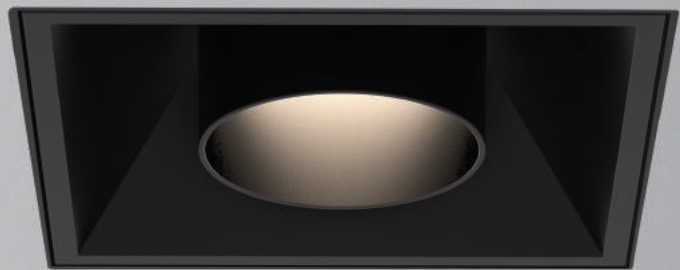

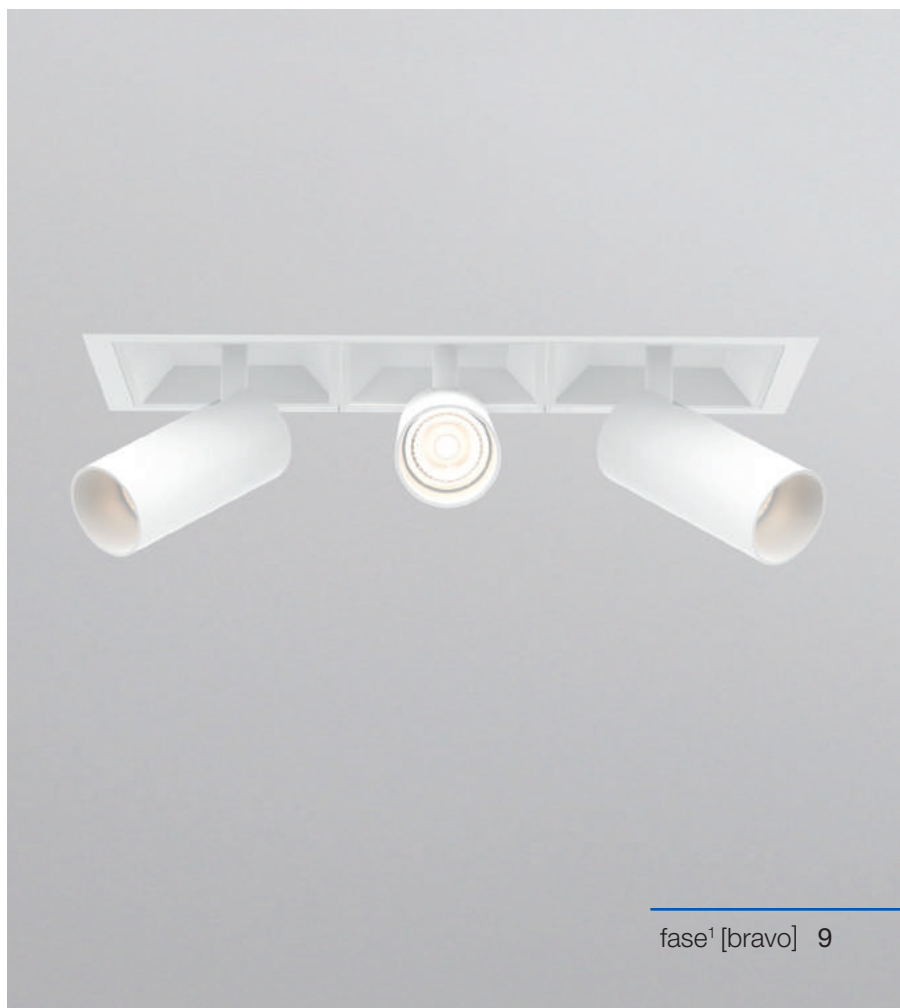
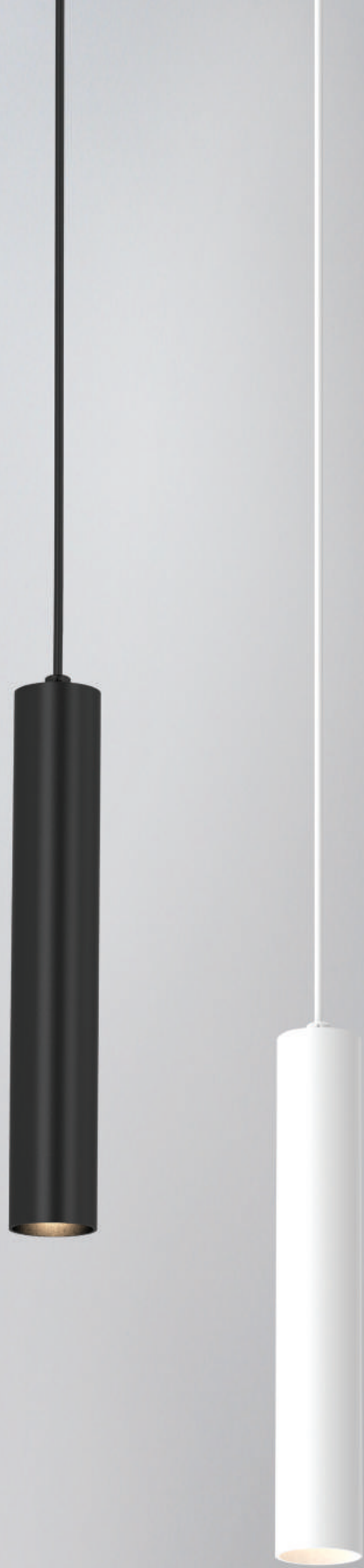

FIXED

As its name implies, this is an immovable light. Directed downward, the angle and size is based on the angle of the beam within its globe. Super easy to install, this option provides even illumination and makes this the common favorite for general lighting.

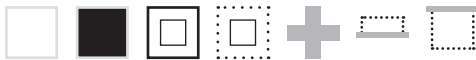

All housing available in white, black, trim, trimless, multiples, recessed and surface mount options

LAMPING

Wattage:	10W	15W
Source:	Integrated LED	Integrated LED
Beam angle:	15°/24°/38°	15°/24°/38°
Kelvin:	2700K/3000K/3500K/4000K	2700K/3000K/3500K/4000K
Lumens:	840lm	1180lm
CRI:	90+	90+
Dimming:	0-10V/ELV/Triac	0-10V/ELV/Triac
Location:	Damp	Damp
Input:	120-277V (347 upon request)	120-277V (347 upon request)
Color:	Black/White	Black/White
Type:	Trim/Trimless	Trim/Trimless
	Surface Mount/Recessed	Surface Mount/Recessed
	1-light/2-light/3-light	1-light/2-light/3-light

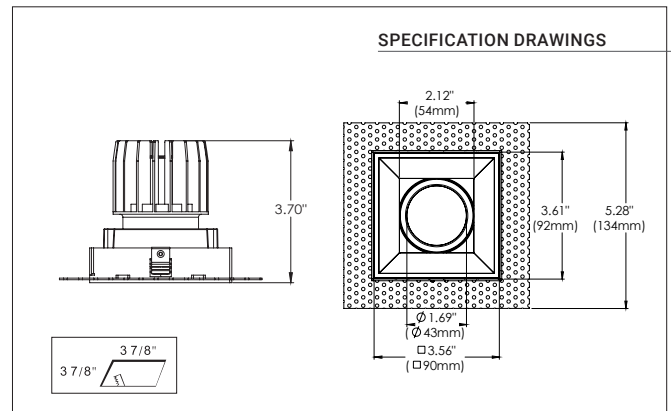

EXAMPLE

Ceiling cut-outs will vary depending on housing. Please refer to each specifications. Example shown is for a recessed 1-light without trim.

10W WIDE

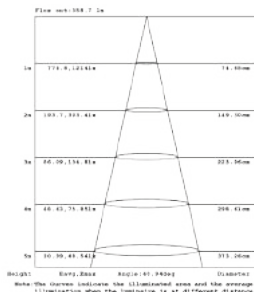
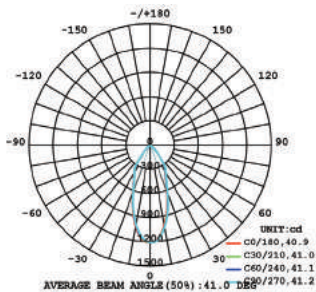

15W WIDE

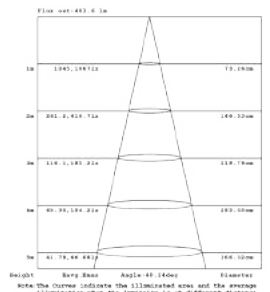
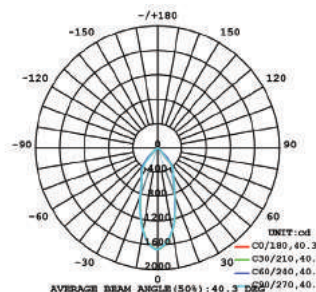

** See pg 32 for full photometrics

*** For customization, please consult Eurofase



GIMBAL

The gimbal is a pivoting support within the housing to limit the lamp from extending outside the ceiling. Rotating the lens around its center of gravity, you can direct light wherever needed to allow a range of directional lighting. The flexibility of its adjustable downlights make this an ideal choice for task and accent lighting.

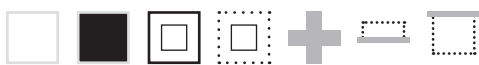

All housing available in white, black, trim, trimless, multiples, recessed and surface mount options

LAMPING

Wattage:	10W	15W
Source:	Integrated LED	Integrated LED
Beam angle:	15°/24°/38°	15°/24°/38°
Kelvin:	2700K/3000K/3500K/4000K	2700K/3000K/3500K/4000K
Lumens:	840lm	1180lm
CRI:	90+	90+
Dimming:	0-10V/ELV/Triac	0-10V/ELV/Triac
Location:	Damp	Damp
Input:	120-277V (347 upon request)	120-277V (347 upon request)
Color:	Black/White	Black/White
Type:	Trim/Trimless	Trim/Trimless
	Surface Mount/Recessed	Surface Mount/Recessed
	1-light/2-light/3-light	1-light/2-light/3-light

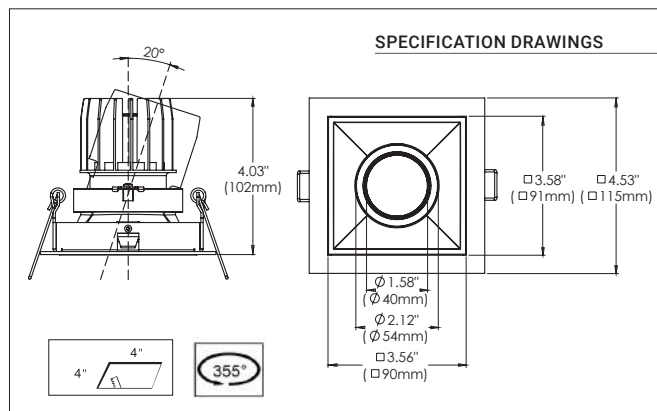

EXAMPLE

Ceiling cut-outs will vary depending on housing. Please refer to each specifications. Example shown is for a recessed 1-light with trim.

10W WIDE

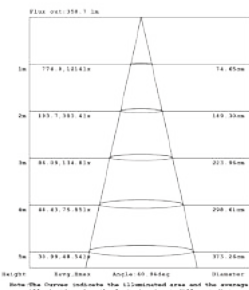
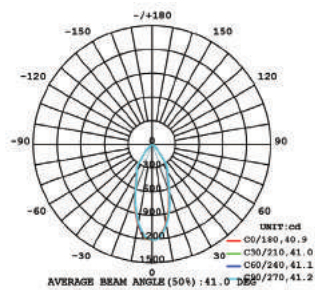

15W WIDE

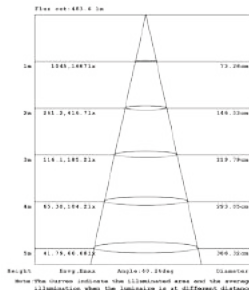
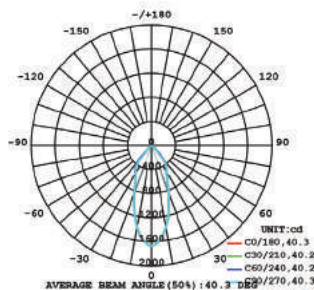

** See pg 32 for full photometrics
 *** For customization, please consult Eurofase



SNOOT GIMBAL

The snoot gimbal is an adaptable light modifier that can isolate the light source to create a very tightly focused beam. Create the dramatic look you want, with less light spill and more defined edges in the light. Now with this option built in, you get the look you want with the added features and convenience especially when dealing with lower ceilings that lack space.

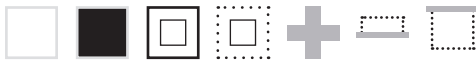

All housing available in white, black, trim, trimless, multiples, recessed and surface mount options

LAMPING

Wattage:	10W	15W
Source:	Integrated LED	Integrated LED
Beam angle:	15°/24°/38°	15°/24°/38°
Kelvin:	2700K/3000K/3500K/4000K	2700K/3000K/3500K/4000K
Lumens:	840lm	1180lm
CRI:	90+	90+
Dimming:	0-10V/ELV/Triac	0-10V/ELV/Triac
Location:	Damp	Damp
Input:	120-277V (347 upon request)	120-277V (347 upon request)
Color:	Black/White	Black/White
Type:	Trim/Trimless	Trim/Trimless
	Surface Mount/Recessed	Surface Mount/Recessed
	1-light/2-light/3-light	1-light/2-light/3-light

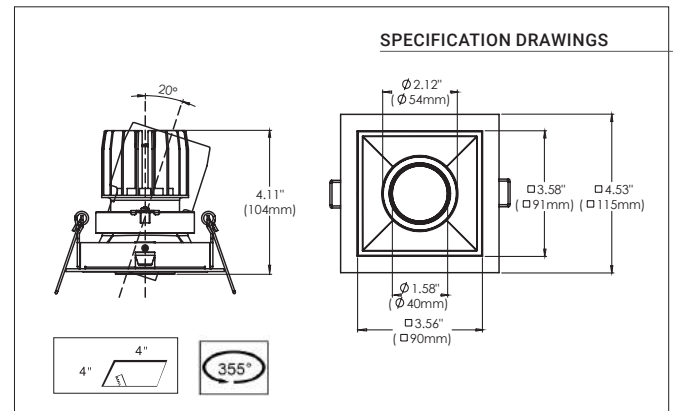

EXAMPLE

Ceiling cut-outs will vary depending on housing. Please refer to each specifications. Example shown is for a recessed 1-light with trim.

10W WIDE

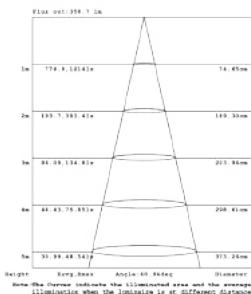
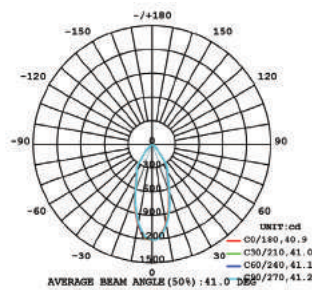

15W WIDE

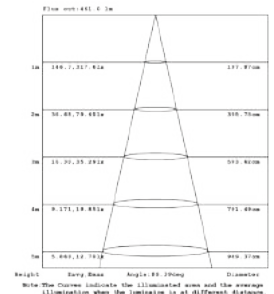
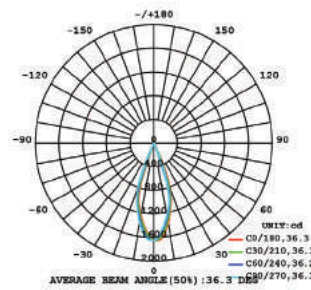

** See pg 33 for full photometrics

*** For customization, please consult Eurofase



WALL WASH*

This fixed module illuminates a vertical surface to either help make a room appear larger or direct attention to an object on the wall. Unlike spot lighting, wall washers can make a larger area brighter and provide a soft diffused radiance to a space.



*Module not compatible with surface mount application due to light engine angle

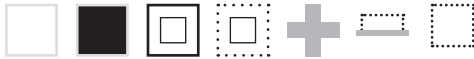

All housing available in white, black, trim, trimless, multiples, recessed and surface mount options

LAMPING

Wattage: 15W
 Source: Integrated LED
 Beam angle: 15°/24°/38°
 Kelvin: 2700K/3000K/3500K/4000K
 Lumens: 760lm
 CRI: 90+
 Dimming: 0-10V/Phase Dimming/Triac
 Location: Damp
 Input: 120-277V (347 upon request)
 Color: Black/White
 Type: Trim/Trimless
 Surface Mount/Recessed
 1-light/2-light/3-light

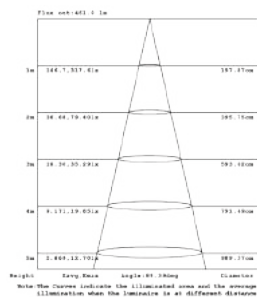
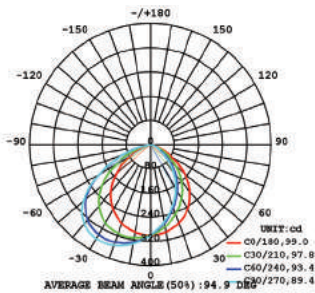

SPECIFICATION DRAWINGS

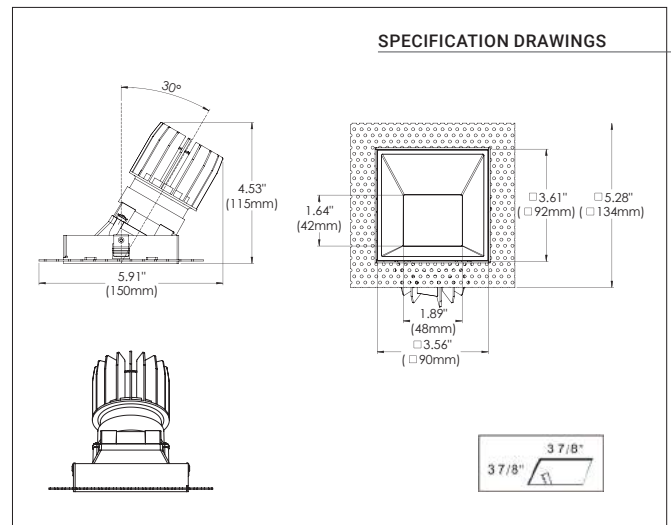

EXAMPLE

Ceiling cut-outs will vary depending on housing. Please refer to each specifications. Example shown is for a recessed 1-light without trim.

** See pg 34 for full photometrics

*** For customization, please consult Eurofase



SUSPENSION*

This hanging module comes ready-to-install onto the plate. It includes the lens and reflector assembled within.

As the more decorative piece of this collection, the suspension module works just like a hanging pendant but has a sleeker and more compact design. It's small canopy sits flush against the ceiling and is available in a trimless option for a seamless look.



*Module includes lens and reflector inside for complete base

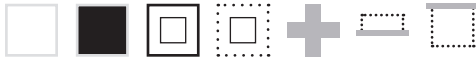

All housing available in white, black, trim, trimless, multiples, recessed and surface mount options

LAMPING

Wattage: 15W
 Source: Integrated LED
 Beam angle: 15°/24°/38°
 Kelvin: 2700K/3000K/3500K/4000K
 Lumens: 1060lm
 CRI: 90+
 Dimming: 0-10V/Phase Dimming/Triac
 Location: Damp
 Input: 120-277V (347 upon request)
 Color: Black/White
 Type: Trim/Trimless
 Surface Mount/Recessed
 1-light/2-light/3-light

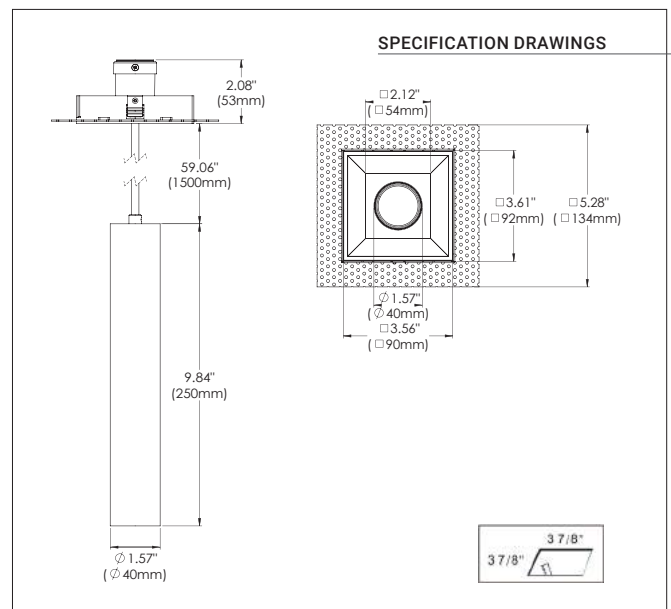
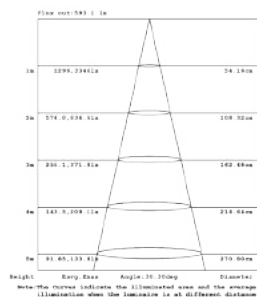
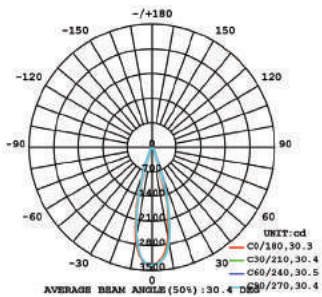

EXAMPLE

Ceiling cut-outs will vary depending on housing. Please refer to each specifications. Example shown is for a recessed 1-light without trim.

** See pg 33 for full photometrics

*** For customization, please consult Eurofase



SPOT*

The spot module is the best choice for directional lighting to highlight specific pieces that deserve that extra attention. For hanging art, sculptures, and even a little reading nook, you can shape the perfect ambiance by adding supplementary layered lighting.



*Module includes lens and reflector inside for complete base

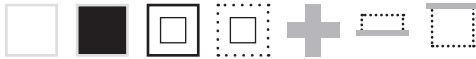

All housing available in white, black, trim, trimless, multiples, recessed and surface mount options

LAMPING

Wattage: 15W
 Source: Integrated LED
 Beam angle: 15°/24°/38°
 Kelvin: 2700K/3000K/3500K/4000K
 Lumens: 1060lm
 CRI: 90+
 Dimming: 0-10V/Phase Dimming/Triac
 Location: Damp
 Input: 120-277V (347 upon request)
 Color: Black/White
 Type: Trim/Trimless
 Surface Mount/Recessed
 1-light/2-light/3-light

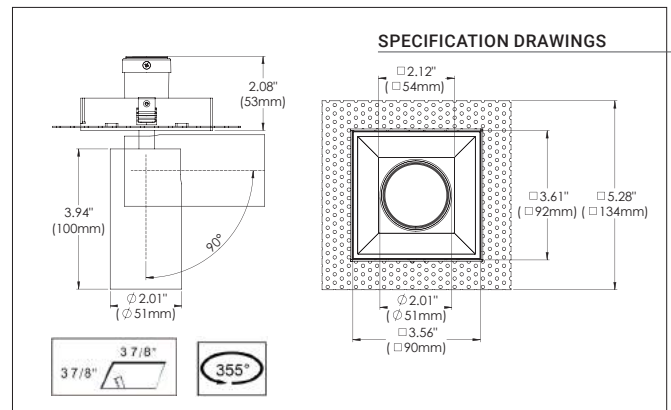

EXAMPLE

Ceiling cut-outs will vary depending on housing. Please refer to each specifications. Example shown is for a recessed 1-light without trim.

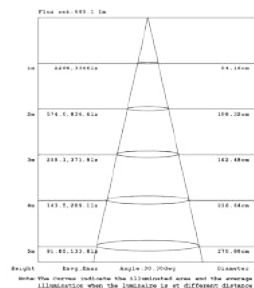
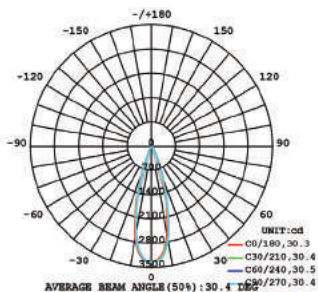

** See pg 34 for full photometrics

*** For customization, please consult Eurofase



MainDish

LOREN PORK DOLLS ST. AMEY 32
LOREN PORK DOLLS ST. AMEY 32
LOREN PORK DOLLS ST. AMEY 32
LOREN PORK DOLLS ST. AMEY 32
LOREN PORK DOLLS ST. AMEY 32
LOREN PORK DOLLS ST. AMEY 32
LOREN PORK DOLLS ST. AMEY 32
LOREN PORK DOLLS ST. AMEY 32
LOREN PORK DOLLS ST. AMEY 32
LOREN PORK DOLLS ST. AMEY 32

SeaFood

LOREN PORK DOLLS ST. AMEY 32
LOREN PORK DOLLS ST. AMEY 32
LOREN PORK DOLLS ST. AMEY 32
LOREN PORK DOLLS ST. AMEY 32
LOREN PORK DOLLS ST. AMEY 32
LOREN PORK DOLLS ST. AMEY 32
LOREN PORK DOLLS ST. AMEY 32
LOREN PORK DOLLS ST. AMEY 32
LOREN PORK DOLLS ST. AMEY 32
LOREN PORK DOLLS ST. AMEY 32

Drink

LOREN PORK DOLLS ST. AMEY 32
LOREN PORK DOLLS ST. AMEY 32
LOREN PORK DOLLS ST. AMEY 32
LOREN PORK DOLLS ST. AMEY 32
LOREN PORK DOLLS ST. AMEY 32
LOREN PORK DOLLS ST. AMEY 32
LOREN PORK DOLLS ST. AMEY 32
LOREN PORK DOLLS ST. AMEY 32
LOREN PORK DOLLS ST. AMEY 32
LOREN PORK DOLLS ST. AMEY 32

MainDish

LOREN PORK DOLLS ST. AMEY 32
LOREN PORK DOLLS ST. AMEY 32
LOREN PORK DOLLS ST. AMEY 32
LOREN PORK DOLLS ST. AMEY 32
LOREN PORK DOLLS ST. AMEY 32
LOREN PORK DOLLS ST. AMEY 32
LOREN PORK DOLLS ST. AMEY 32
LOREN PORK DOLLS ST. AMEY 32
LOREN PORK DOLLS ST. AMEY 32
LOREN PORK DOLLS ST. AMEY 32

SeaFood

LOREN PORK DOLLS ST. AMEY 32
LOREN PORK DOLLS ST. AMEY 32
LOREN PORK DOLLS ST. AMEY 32
LOREN PORK DOLLS ST. AMEY 32
LOREN PORK DOLLS ST. AMEY 32
LOREN PORK DOLLS ST. AMEY 32
LOREN PORK DOLLS ST. AMEY 32
LOREN PORK DOLLS ST. AMEY 32
LOREN PORK DOLLS ST. AMEY 32
LOREN PORK DOLLS ST. AMEY 32

Drink

LOREN PORK DOLLS ST. AMEY 32
LOREN PORK DOLLS ST. AMEY 32
LOREN PORK DOLLS ST. AMEY 32
LOREN PORK DOLLS ST. AMEY 32
LOREN PORK DOLLS ST. AMEY 32
LOREN PORK DOLLS ST. AMEY 32
LOREN PORK DOLLS ST. AMEY 32
LOREN PORK DOLLS ST. AMEY 32
LOREN PORK DOLLS ST. AMEY 32
LOREN PORK DOLLS ST. AMEY 32

MainDish

LOREN PORK DOLLS ST. AMEY 32
LOREN PORK DOLLS ST. AMEY 32
LOREN PORK DOLLS ST. AMEY 32
LOREN PORK DOLLS ST. AMEY 32
LOREN PORK DOLLS ST. AMEY 32
LOREN PORK DOLLS ST. AMEY 32
LOREN PORK DOLLS ST. AMEY 32
LOREN PORK DOLLS ST. AMEY 32
LOREN PORK DOLLS ST. AMEY 32
LOREN PORK DOLLS ST. AMEY 32

SeaFood

LOREN PORK DOLLS ST. AMEY 32
LOREN PORK DOLLS ST. AMEY 32
LOREN PORK DOLLS ST. AMEY 32
LOREN PORK DOLLS ST. AMEY 32
LOREN PORK DOLLS ST. AMEY 32
LOREN PORK DOLLS ST. AMEY 32
LOREN PORK DOLLS ST. AMEY 32
LOREN PORK DOLLS ST. AMEY 32
LOREN PORK DOLLS ST. AMEY 32
LOREN PORK DOLLS ST. AMEY 32

Drink

LOREN PORK DOLLS ST. AMEY 32
LOREN PORK DOLLS ST. AMEY 32
LOREN PORK DOLLS ST. AMEY 32
LOREN PORK DOLLS ST. AMEY 32
LOREN PORK DOLLS ST. AMEY 32
LOREN PORK DOLLS ST. AMEY 32
LOREN PORK DOLLS ST. AMEY 32
LOREN PORK DOLLS ST. AMEY 32
LOREN PORK DOLLS ST. AMEY 32
LOREN PORK DOLLS ST. AMEY 32

PANEL*

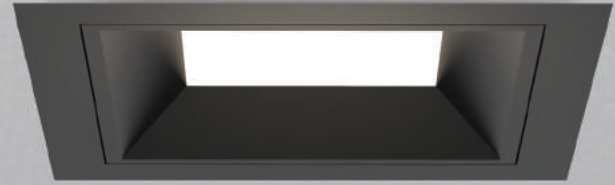

Originally made as a solution to replace conventional fluorescent ceiling lights, panel lighting offers amazing quality diffused lighting.

With the ability to be housed in the Bravo collection, you can now integrate it with your design as recessed and/or surface mounted.

*Module includes lens and reflector inside for complete base

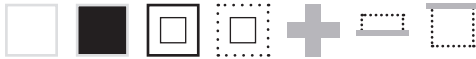

All housing available in white, black, trim, trimless, multiples, recessed and surface mount options

LAMPING

Wattage: 15W
 Source: Integrated LED
 Beam angle: 15°/24°/38°
 Kelvin: 2700K/3000K/3500K/4000K
 Lumens: 630lm
 CRI: 90+
 Dimming: 0-10V/Phase Dimming/Triac
 Location: Damp
 Input: 120-277V (347 upon request)
 Color: Black/White
 Type: Trim/Trimless
 Surface Mount/Recessed
 1-light/2-light/3-light

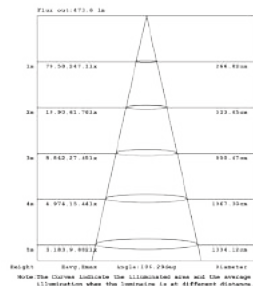
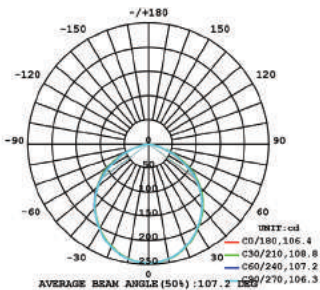

SPECIFICATION DRAWINGS

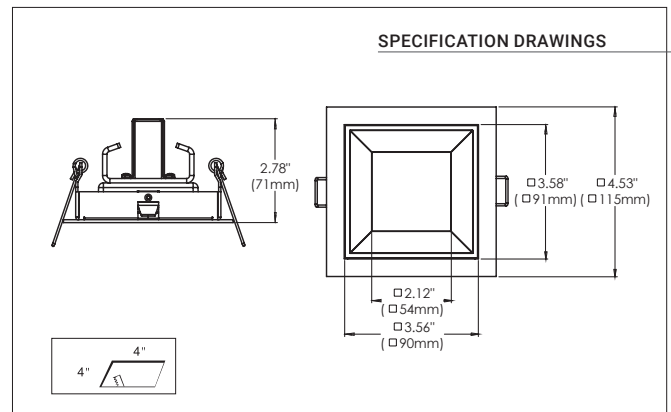

EXAMPLE

Ceiling cut-outs will vary depending on housing. Please refer to each specifications. Example shown is for a recessed 1-light with trim.

** See pg 34 for full photometrics

*** For customization, please consult Eurofase



01

ACCESSORIES

OPTIC REFLECTORS: Beam Angle

Spot	Narrow 15°
Flood	Medium 24°
Wide Flood	Wide 38°

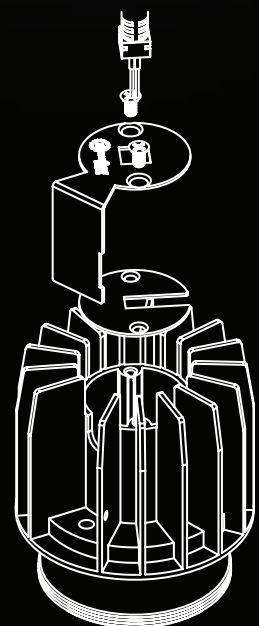

Reflectors installed into the light engine, before the diffusers

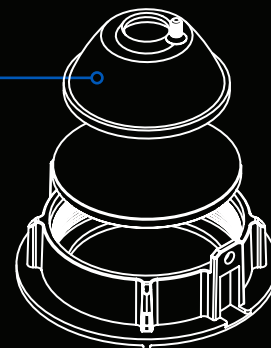

02

LENS: Diffuser

Standard Lens (INCLUDED)

Clear glass protective lens

Dichroic Lens

Accurately filter colors to change room ambiance (Orange/Red/Blue/Green)

Spread Lens

Wider beam diffuser to focus on larger objects

Linear Spread Lens

Oval flood beam best suited for wall washing applications

Frosted Lens

Disperses light evenly with a soft, diffused glow

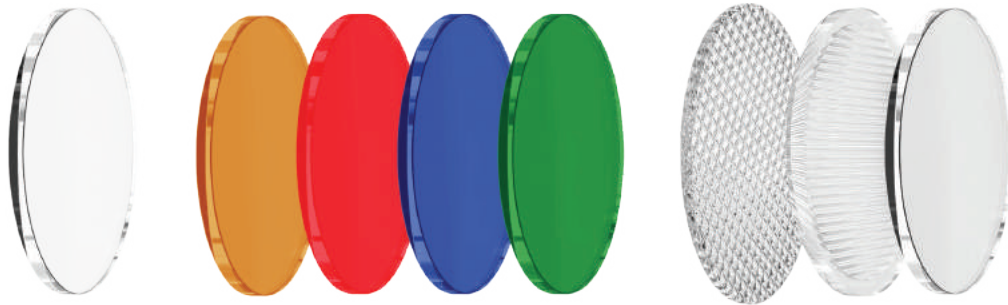

03

AD-ONS: Extensions

Extension Baffle

This extension baffle focuses the light beam, which reduces light spill and improves lighting efficiency. Adding the extension baffle along with your choice of reflector greatly improves the illumination your downlight produces.

Honeycomb Louvre

This slim filter has lighting comfort properties for optimal illumination. The honeycomb louvre reduces glare, distortion and provides better clarity.



LASTING IMPRESSION

The Bravo collection are UL Listed to ensure safe operation for many years to come. We want to ensure your success with every project you tackle. We're also offering a 5 year limited warranty.





HOUSINGS

FIXED

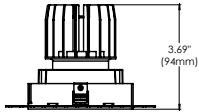

GIMBAL

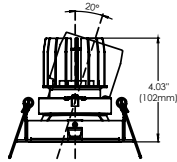

SNOOT

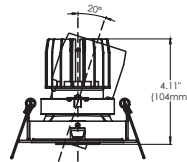

SUSPENSION

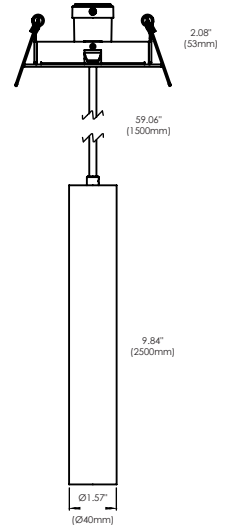

SPOT

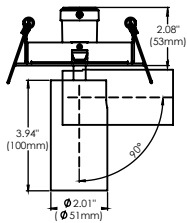

WALLWASHER

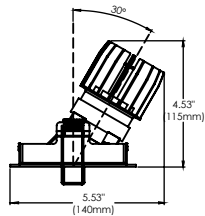

PANEL

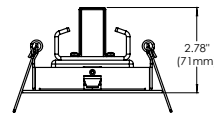

RECESSED

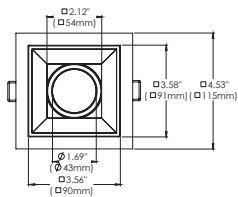

1 Light Square Trim - Bottom View

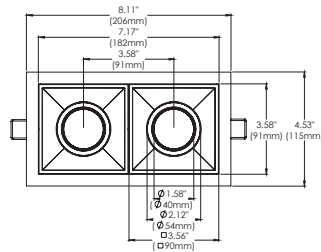

2 Light Square Trim - Bottom View

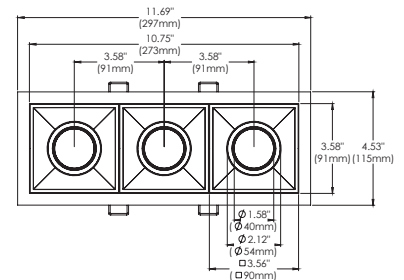

3 Light Square Trim - Bottom View

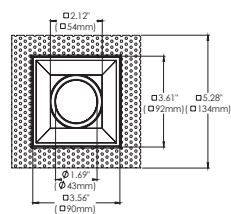

1 Light Square Trimless - Bottom View

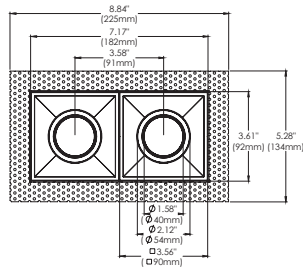

2 Light Square Trimless - Bottom View

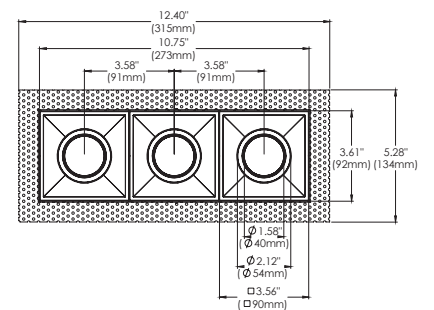

3 Light Square Trimless - Bottom View

SURFACE MOUNT

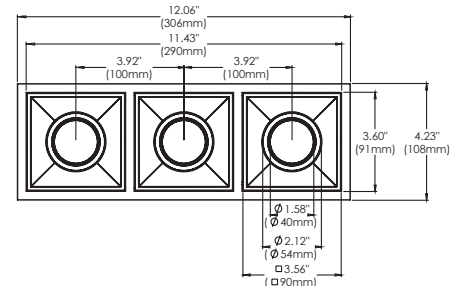
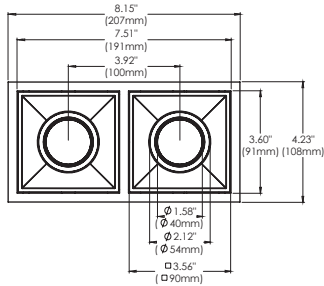
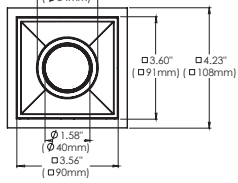
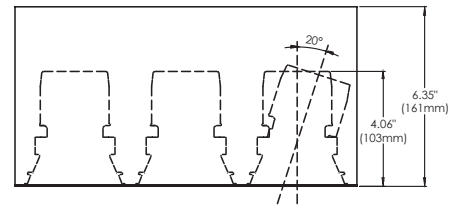
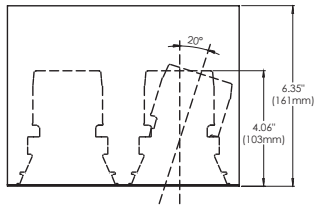
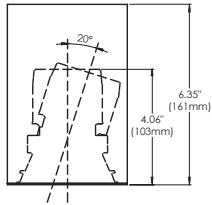

1-Light IC Box + NC Plate

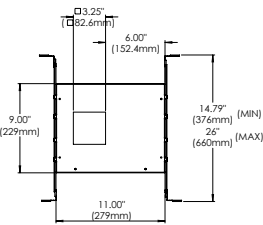

NCP and IC/AT
1-Light Square

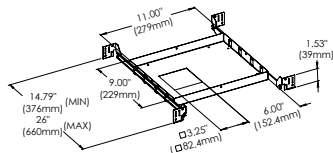

NCP 1-Light Square
41946-015

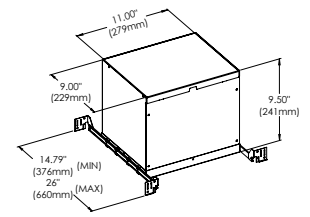

IC 1-Light Square
41947-012
AT 1-Light Square
41948-019

2-Light IC Box + NC Plate

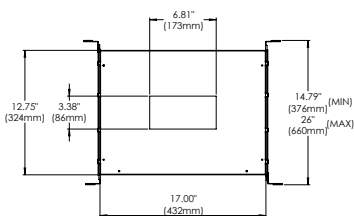

NCP and IC/AT
2-Light Rectangular

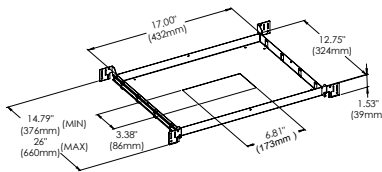

NCP 2-Light Rectangular
41949-016

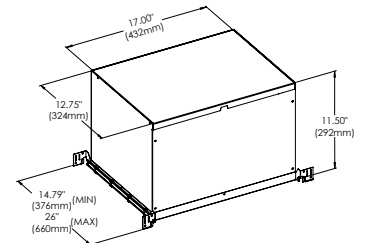

IC 2-Light Rectangular
41950-012
AT 2-Light Rectangular
41951-019

3-Light IC Box + NC Plate

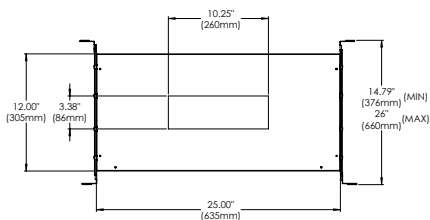

NCP and IC/AT
3-Light Rectangular

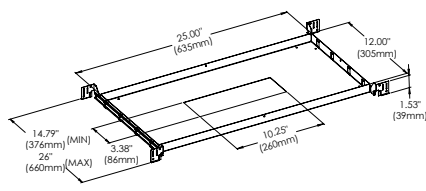

NCP 3-Light Rectangular
41952-016

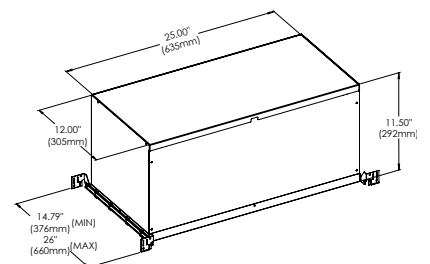

IC 3-Light Rectangular
41953-013
AT 3-Light Rectangular
41954-010

INSTALLATION GUIDE

RECESSED

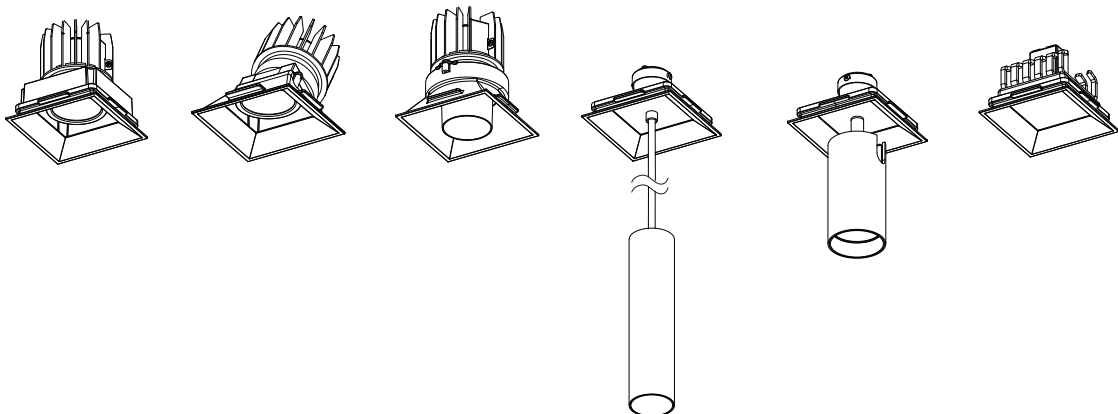
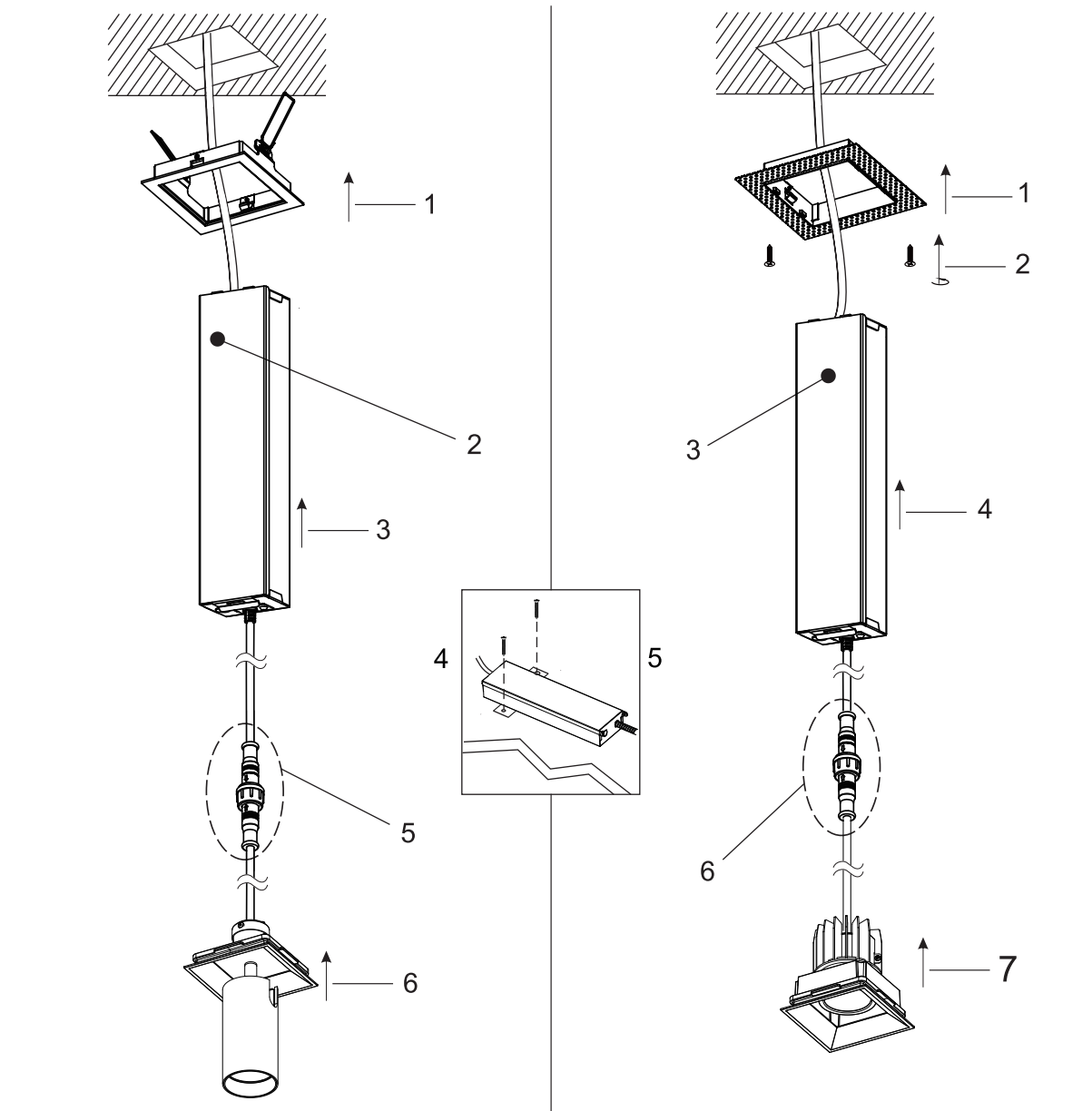

SURFACE MOUNT

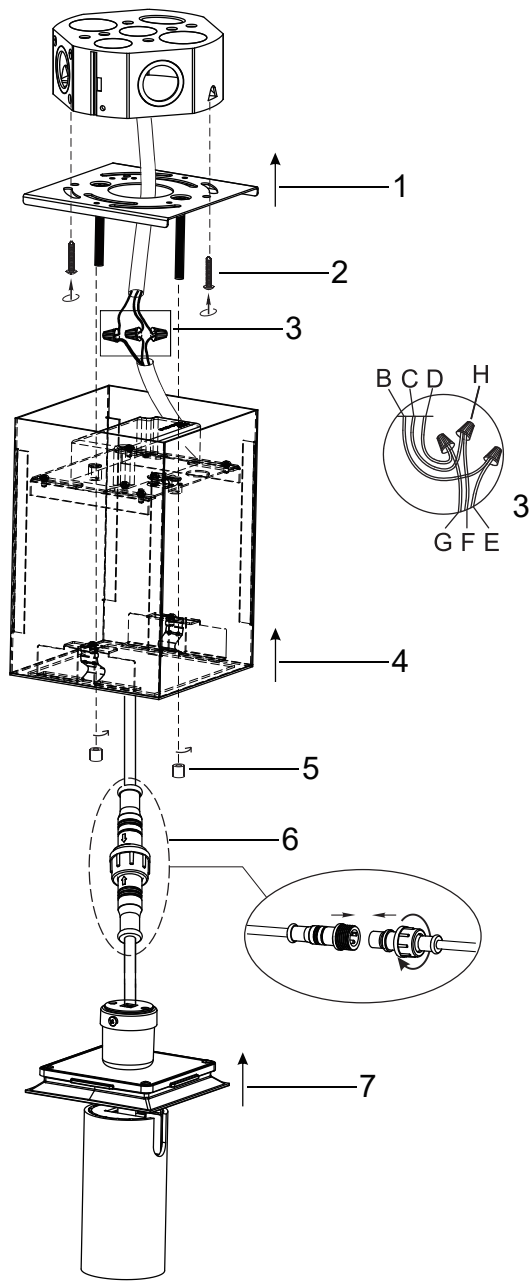

PHOTOMETRICS

Each Bravo module sports an aluminum body with powder coated finish and aluminum die cast trim that makes this versatile collection extremely durable. Its housing design with propriety hidden heat sink mechanism protects LED life for longevity as it increases the heat flow away by absorbing thermal energy and then dispersing it into the surrounding ambient air.

FIXED



10W 1-LIGHT FIXED NARROW CLEAR

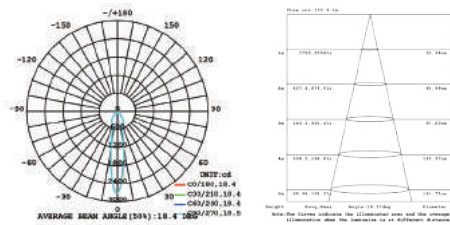

10W 1-LIGHT FIXED MEDIUM CLEAR

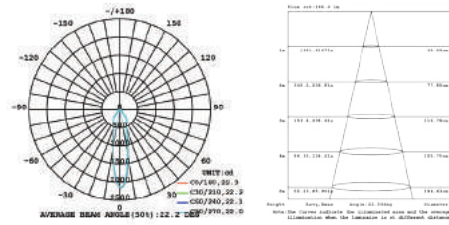

10W 1-LIGHT FIXED WIDE CLEAR

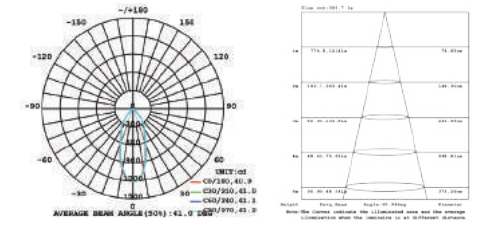

15W 1-LIGHT FIXED NARROW CLEAR

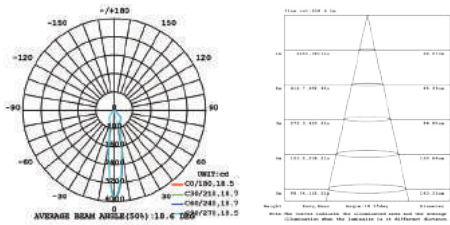

15W 1-LIGHT FIXED MEDIUM CLEAR

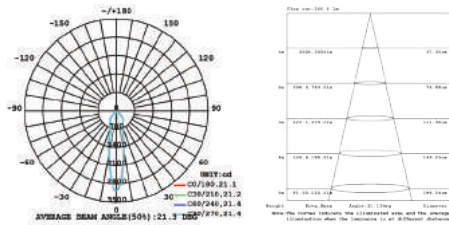

15W 1-LIGHT FIXED WIDE CLEAR

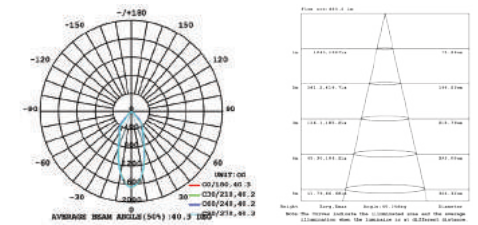

GIMBAL



10W 1-LIGHT GIMBAL NARROW CLEAR

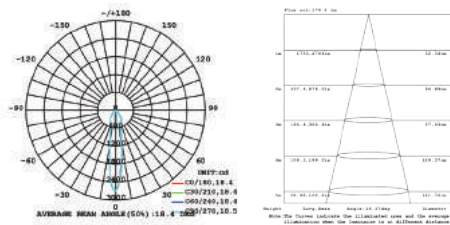

10W 1-LIGHT GIMBAL MEDIUM CLEAR

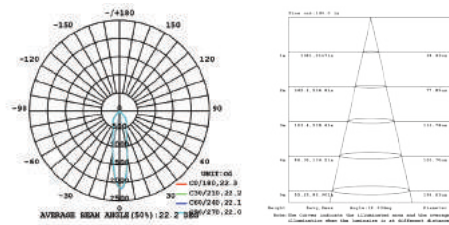

10W 1-LIGHT GIMBAL WIDE CLEAR

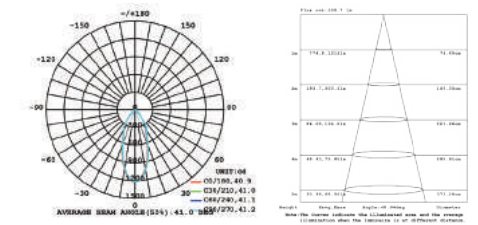

15W 1-LIGHT GIMBAL NARROW CLEAR

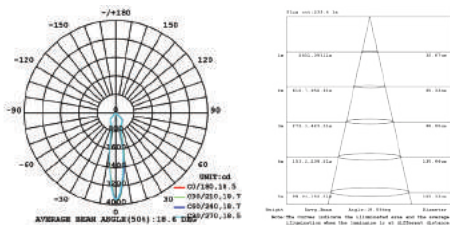

15W 1-LIGHT GIMBAL MEDIUM CLEAR

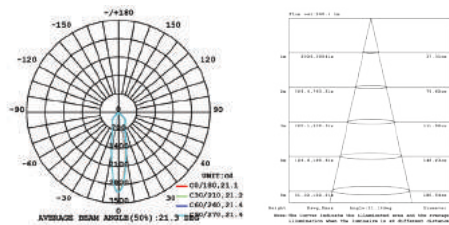

15W 1-LIGHT GIMBAL WIDE CLEAR

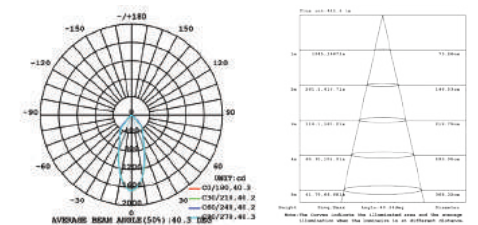

SNOOT



10W 1-LIGHT FIXED NARROW CLEAR

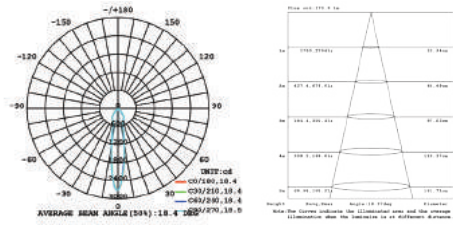

10W 1-LIGHT FIXED MEDIUM CLEAR

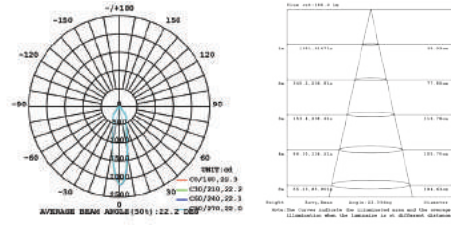

10W 1-LIGHT FIXED WIDE CLEAR

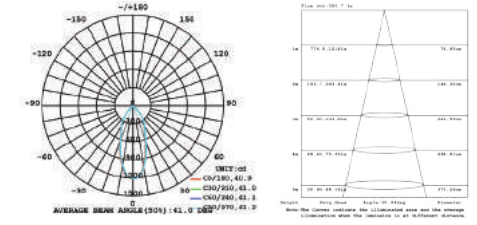

15W 1-LIGHT FIXED NARROW CLEAR

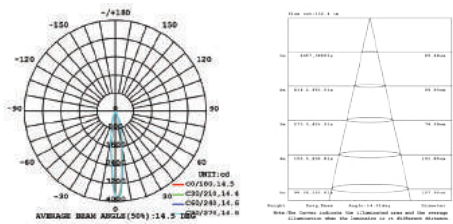

15W 1-LIGHT FIXED MEDIUM CLEAR

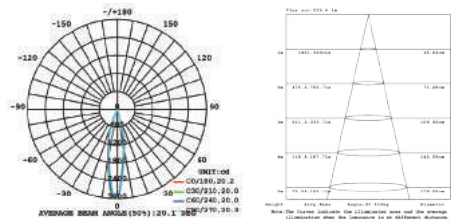

15W 1-LIGHT FIXED WIDE CLEAR

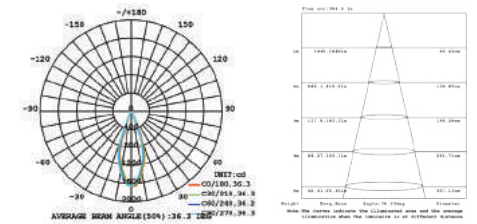

SUSPENSION

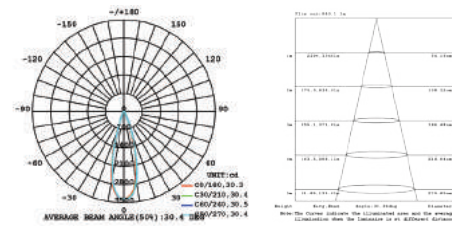

WALL WASH*

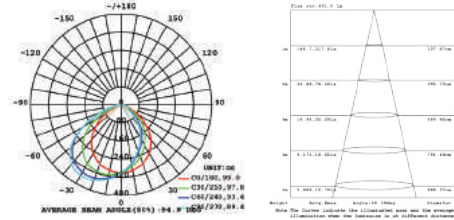

*Module not compatible with surface mount application due to light engine angle

SPOT

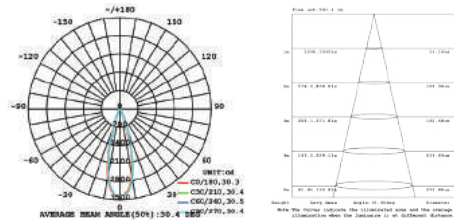

PANEL

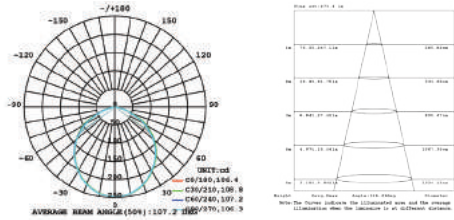





EASY AS 1 2 3

Adding or removing accessories can easily be done in 3 simple steps.

Field Adjustable

With an extensive list of customized options, it is our goal to make the application exceptionally uncomplicated. Each light engine is equipped with quick connect attachments for ease of installation. This allows individual modules to be interchanged well after the installation is made. When recessed lighting is already installed, it is harder to maneuver around the product to make even the simplest of changes but this mitigates all that. This handy feature is especially beneficial in the event a module burns out.

Quick Connect

Simply twist the latch to reveal the connector beneath and then separate the cables in 2 easy steps.

IC-Rated Engine

An IC-rated light engine at 10W is now available for even more applications along with 2 CCT light engines to cover a range from 2700K to 4000K.

High Performance LED Chip + Driver

Employs an ESS Series LED Driver with Tri-Mode Dimming and worldwide safety approvals.

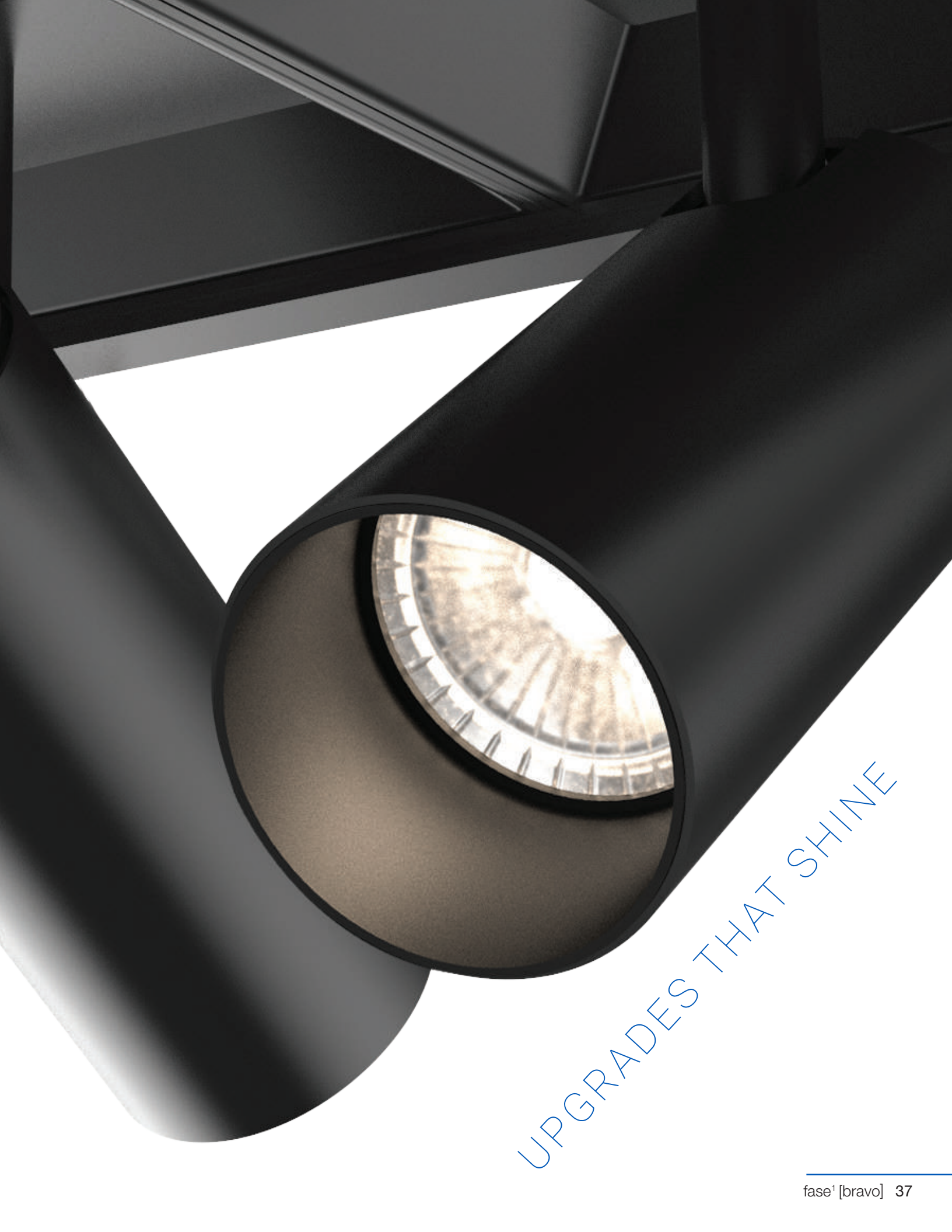

UPGRADES THAT SHINE



FULL CONTROL

Start at the very beginning by figuring out how many lights you would like. Choose from a 1-, 2-, or 3-light base then move onto your preferred shape. Options include a round or square form in black or white. From there, you can also decide whether or not to include a trim or leave it trimless for a seamless look and feel.

ORDERING GUIDE

Start at the very beginning by figuring out how many lights you would like. Choose from a 1-, 2-, or 3-light base then move onto your preferred shape. Options include a round or square form with or without trim. From there, you can decide to use either black or white to match your decor.

1 This first step involves 5 easy parts.

Choose:
Recessed or Surface Mount | No. of lights | Shape | Trim or Trimless | Color

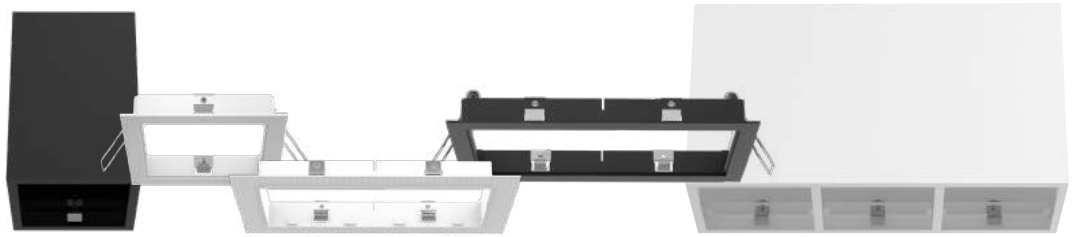

2 Decide the type of lighting required

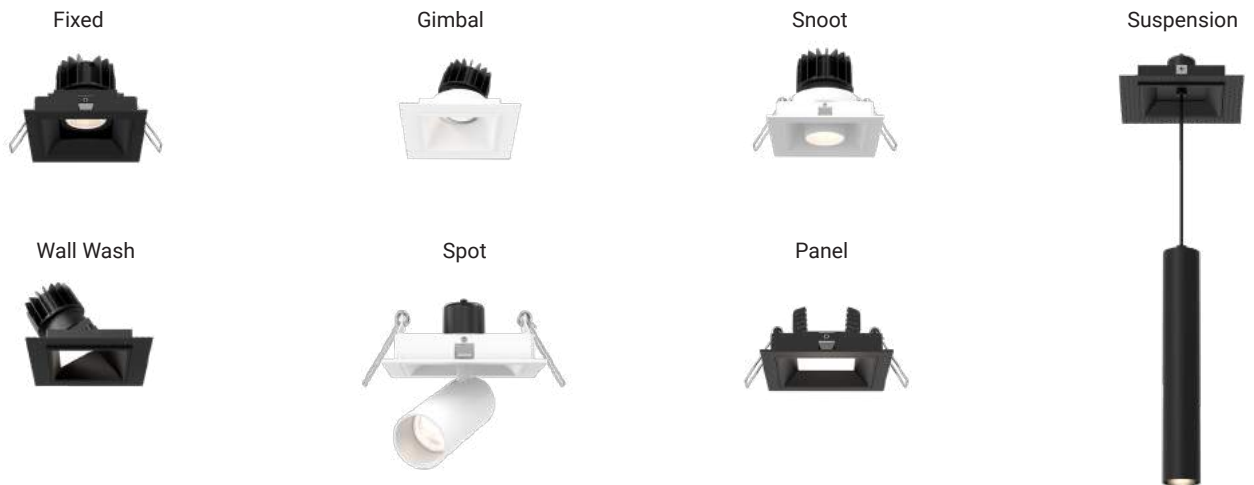

3 Design your configuration

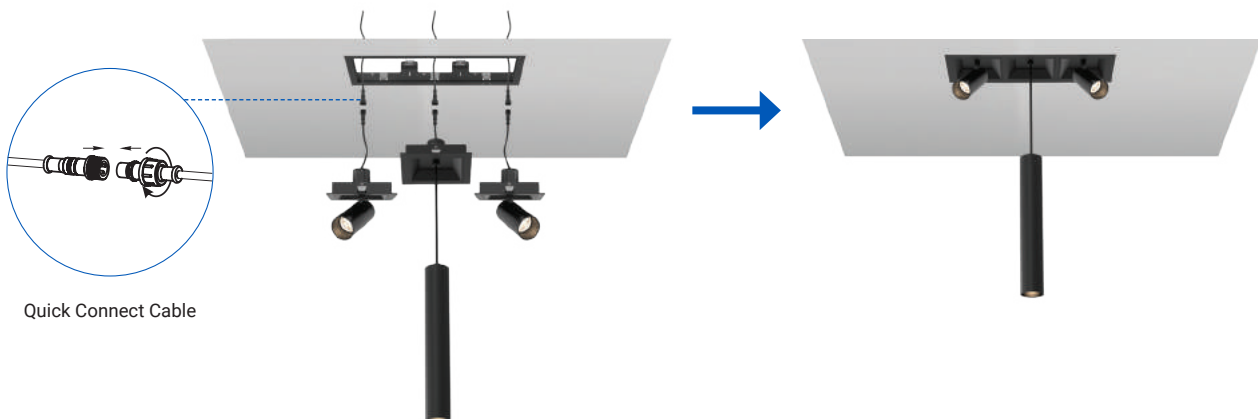

CONFIGURATOR

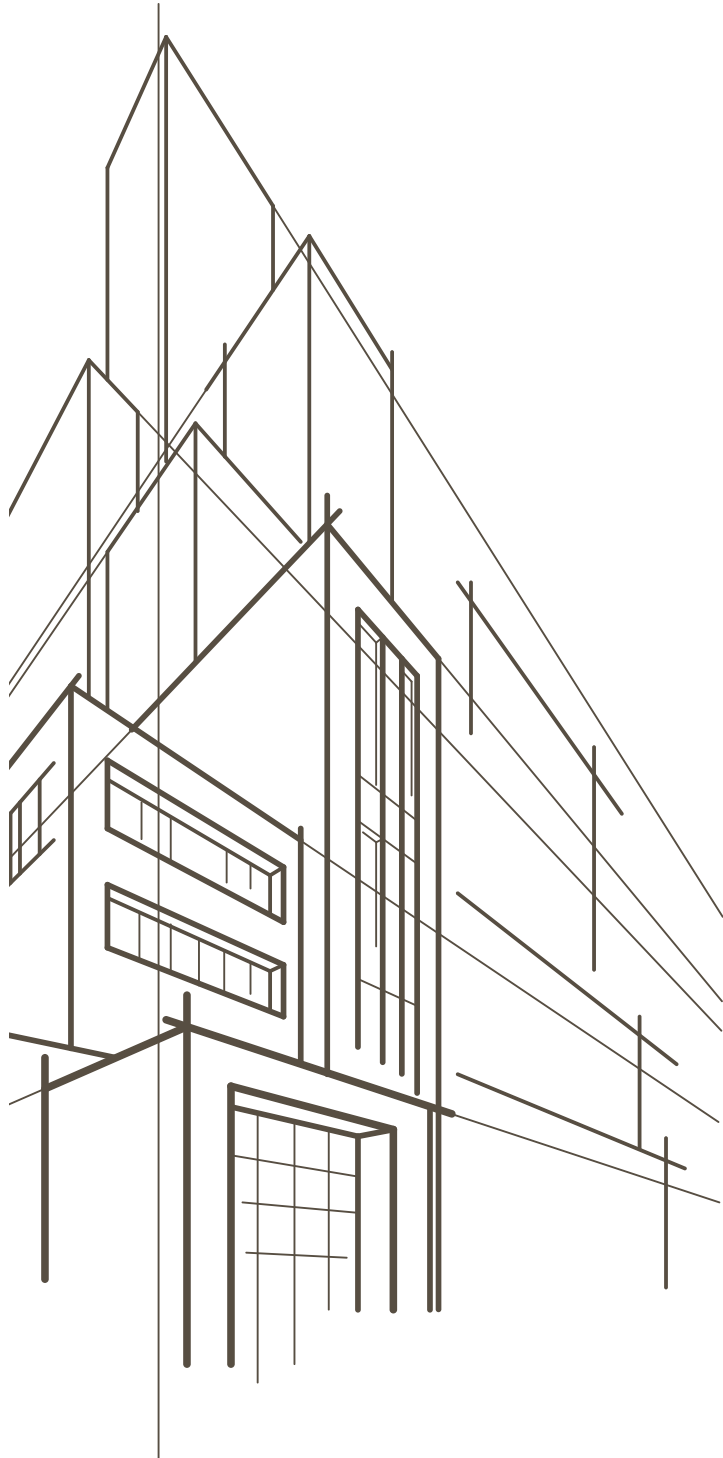

BEGIN BUILDING YOUR 1-LIGHT CONFIGURATION

PART A

If you are designing for a 1-light configuration, continue onto PART C.

CONTINUE CHOOSING YOUR MODULES FOR 2-LIGHT AND 3-LIGHT HOUSINGS

PART B

If you are designing for a 2-light or 3-light configuration, continue to choose your modules accordingly..

COMPLETE YOUR ORDER BY CHOOSING YOUR SPECIFICS

PART C

Finish your order by choosing the wattage, color temperature, beam angle, and the diffuser accessory.

COLLECTION (FAMILYNAME)	MOUNTING		NO. OF LIGHTS		TRIM		COLOR		MODULE 01	
BVO	S	SURFACE MOUNT	1	1 LIGHT	T	TRIMMED	01	BLACK	RF	RECESSED FIXED
	R	RECESSED	2	2 LIGHT	TL	TRIMLESS	02	WHITE	RG	RECESSED GIMBAL
			3	3 LIGHT					SG	RECESSED SNOOT GIMBAL
									SU	SUSPENSION
									ST	SPOT
									WL	WALL WASH
									PN	PANEL

MODULE 02		MODULE 03	
RF	RECESSED FIXED	RF	RECESSED FIXED
RG	RECESSED GIMBAL	RG	RECESSED GIMBAL
SG	RECESSED SNOOT GIMBAL	SG	RECESSED SNOOT GIMBAL
SU	SUSPENSION	SU	SUSPENSION
ST	SPOT	ST	SPOT
WL	WALL WASH	WL	WALL WASH
PN	PANEL	PN	PANEL

WATT		CCT		BEAM ANGLE		DIFFUSER		ADD-ONS	
10	10W IC	27	2700K	N	15° NARROW	CL	CLEAR DIFFUSER	XL	EXTENSION BAFFLE
15	15W NON-IC	30	3000K	M	24° MEDIUM	LN	LINEAR SPREAD DIFFUSER	HC	HONEYCOMB LOUVRE
		35	3500K	W	38° WIDE	FR	FROSTED DIFFUSER		
		40	4000K			SP	SPREAD DIFFUSER		
						RE	RED DICHROIC		
						GR	GREEN DICHROIC		
						BL	BLUE DICHROIC		
						OR	ORANGE DICHROIC		

Fase¹™

33 West Beaver Creek Road,
Richmond Hill, Ontario Canada L4B 1L8

DALLAS TRADE MART
Eurofase Showroom, Suite #4002

tel 905.695.2055
fax 905.695.2056

toll free 1.800.660.5391
toll free 1.800.660.5390



Printed in Canada
© 2021 Eurofase Inc. All rights reserved.

Eurofase Inc. reserves the right to make alterations to the construction and design of products shown in this catalog in order to meet the laws or regulations of any authorized governing organization. The use of products shown in this catalog must comply with local building codes.