

PROJECT: _____

TYPE: _____ DATE: _____

NOTES: _____



FEATURES

With its robust yet elegant extruded aluminum body and powder coated paint finish Whiskey LED cylinders are both visually stunning and highly functional. There are several different models designed to suit, surface, suspended and wall mount installations. These fixtures are available in two diameters (slim and broad) and three different lengths. With their wide range of installation types, fixture sizes and lumen packages Whiskey LED cylinders are ideal for commercial, residential and hospitality settings.

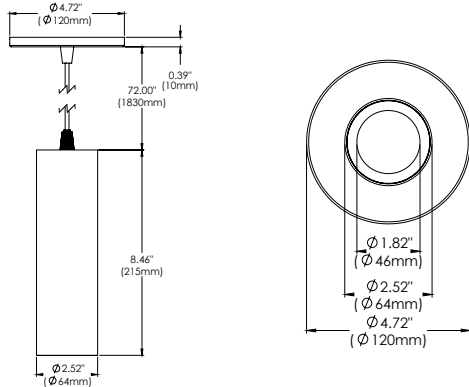

BAFFLE FINISHES

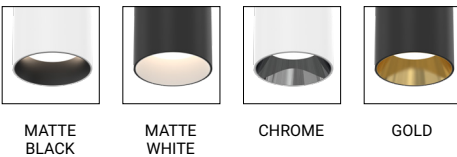

SPECIFICATIONS

FIXTURE BODY	Extruded aluminum body powder coat painted
INSTALLATION TYPE	Mounts over existing octagon box c/w 72" max suspension wire.
CYLINDER DIMENSIONS	H: 8.46" x Dia: 2.52"
COLOR FINISH	Black/White/Custom
LIGHT MODULE	High output, high efficiency LED COB. Lumen Maintenance: 70%@50,000 hrs
INPUT VOLTAGE	120V - 277V
WATTAGE	13W
POWER SUPPLY	ERP, Constant Current 350mA power supply located inside the top of the cylinder body. Minimum operating temperature: -30°
CRI	90+
DIMMING	TRIAC/ELV/0-10V
LUMENS	1260 Lumens
CCT OPTIONS	2700K/3000K/3500K/4000K
BAFFLE OPTIONS	(01) Matte Black (02) Matte White (03) Chrome (04) Gold
REFLECTORS	(N) Narrow 15° (M) Medium 24° (W) Wide 38°
DIFFUSERS	(CL) Clear (LN) Linear Spread (HC) Honeycomb (FR) Frosted (SP) Solite
APPROVAL	Damp
ELECTRICAL APPROVAL	Compliant
WARRANTY	

SPECIFICATION GUIDE

WHISKEY	SUSPENSION	FINISH	CYLINDER SIZE	WHISKEY BAFFLE FINISH	WATTAGE	CCT	BEAM ANGLE	DIFFUSER
WHS	SU	01	SL8	SLIM 8"	01	13	15°	CL
								CLEAR
		02			02	30	24°	LN
								LINEAR SPREAD
		03			03	35	38°	HC
								HONEYCOMB
		04			04	40		FR
								FROSTED
				SP				
				SOLITE				

ORDERING GUIDE EXAMPLE 1:
Whiskey / Suspension / Black / Slim 8" / Chrome /
13W / 3000K / 38° Beam Angle / Clear Diffuser
CODE: WHS-SU-01-SL8-03-13-30-W-CL

REFLECTOR OPTIONS

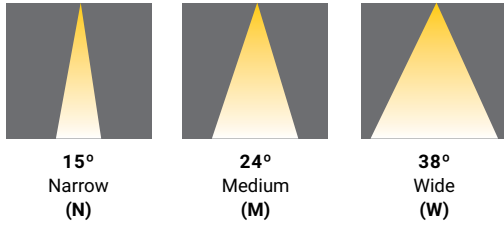

DIFFUSER OPTIONS

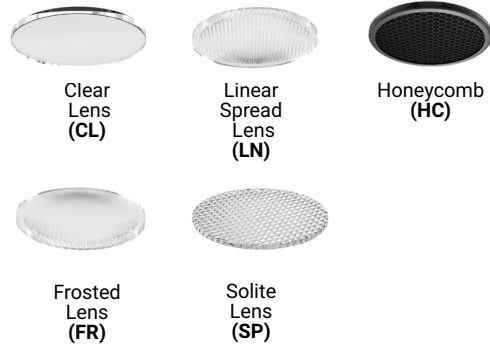

DRIVERS

- Compatible with TRIAC (forward-phase or leading-edge) ELV (reverse-phase or trailing edge) and 0-10V dimmers.
- ESSxxxW models: TRIAC and ELV dimming only at 120 Vac
- ESSxxxW models: ELV dimming only at 230 Vac
- 90° C maximum case hot spot temperature
- Class 2 power supply
- Lifetime: 50,000 hours at 70° case hot spot temperature (some models have a higher lifetime)
- IP64-rated (IP66 for ESST) case with silicone-based potting
- Protections: Output open load, over-current and short-circuit (hiccup), and over-temperature with auto recovery.
- Conducted and radiated EMI: Compliant with FCC CFR Title 47 Part 15 Class B (120 Vac) and Class A (277 Vac), and EN55015 (CISPR 15) at 220, 230, and 240 Vac.
- Complies with ENERGY STAR®, DLC (DesignLight Consortium®) and CA Title 24 technical requirements
- Worldwide safety approvals

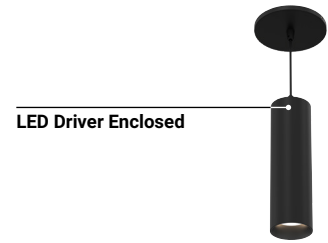

PHOTOMETRICS

13W NARROW CLEAR - SLIM

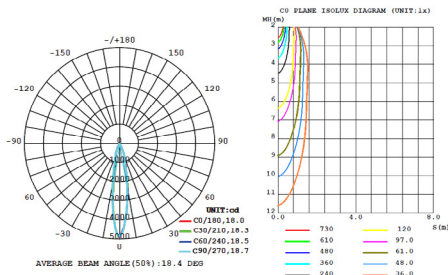

13W MEDIUM CLEAR - SLIM

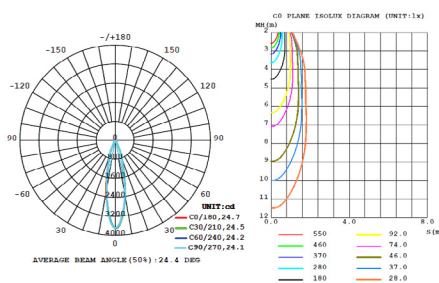

13W WIDE CLEAR - SLIM

