

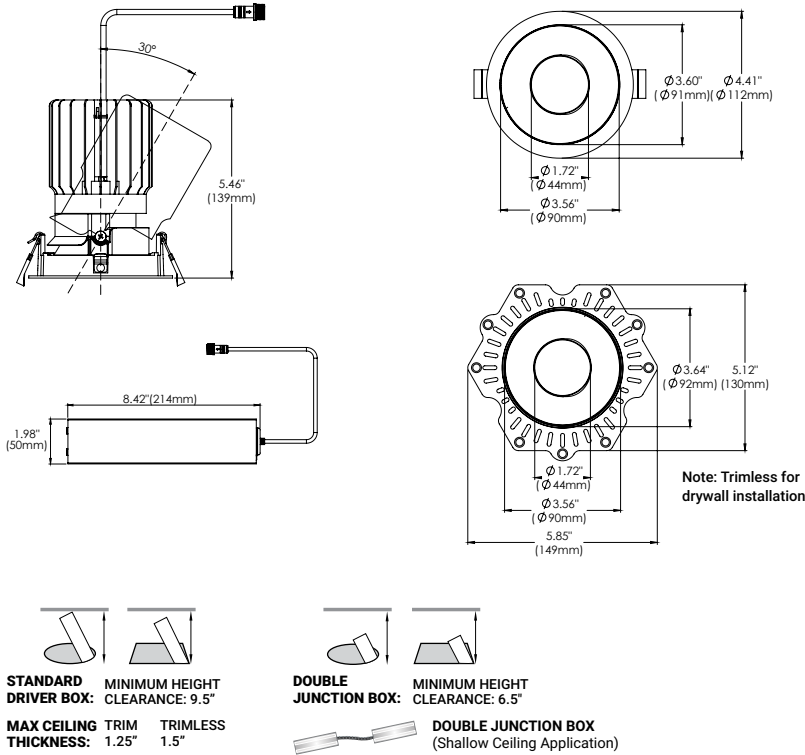

FEATURES

With their smooth, flat and edgeless design, Oscar family recessed luminaires become a seamless part of ceiling decor. With 3 different light modules suited for ambient and accent lighting, the Oscar family is as highly functional as it is visually appealing. Numerous ordering options allow for further functional and artistic customization. Oscar recessed luminaires are available in larger sizes with higher lumen packages making them ideal for both residential and commercial settings.



SPECIFICATIONS

FIXTURE BODY	18 gauge powder coated steel body. Aluminum powder coated trim or trimless mesh plate
INSTALLATION TYPE	Remodel/existing ceiling N/C plate, IC Box on page 2
CUT HOLE	Trim: Ø4" Trimless: Ø4"
COLOR FINISH	Black/White/Custom
LIGHT MODULE	High output, high efficiency LED COB. Lumen Maintenance: 70%@50,000 hrs
INPUT VOLTAGE	120V - 277V
WATTAGE	26W Non-IC Rated
POWER SUPPLY	ERP 26W, Constant Current 700mA power supply Minimum operating temperature: -30° Enclosed in a Junction box with 12" flexible cable to mate to module connector
CRI	90+
DIMMING	TRIAC/ELV/0-10V
LUMENS	26W, 1200 Lumens
CCT OPTIONS	2700K/3000K/3500K/4000K
REFLECTORS	(N) Narrow 15°/(M) Medium 24°/(W) Wide 38°
DIFFUSERS	(CL) Clear/(LN) Linear Spread/(HC) Honeycomb (FR) Frosted/(SP) Solite/(RE) Red Dichroic/(GR) Green Dichroic/(BL) Blue Dichroic/(OR) Orange Dichroic
APPROVAL	Damp
ELECTRICAL APPROVAL	Compliant
WARRANTY	

SPECIFICATION GUIDE

OSCAR	4	SHAPE	TRIM/TRIMLESS	FINISHES	LIGHT MODULE	BAFFLE FINISHES	WATTAGE	CCT	BEAM ANGLE	DIFFUSER	ADD-ONS
OSC	4	R ROUND	T TRIM	01 BLACK	RG RECESSED GIMBAL	01 MATTE BLACK	26 26W	27	N 150	CL CLEAR	DJ DOUBLE JUNCTION BOX
			TL TRIMLESS	02 WHITE		02 MATTE WHITE		30	M 240	LN LINEAR SPREAD	
						03 GOLD		35	W 380	HC HONEYCOMB	
						04 CHROME		40		FR FROSTED	
						05 DARK CHROME				SP SOLITE	
										RE RED DICHROIC	
										GR GREEN DICHROIC	
										BL BLUE DICHROIC	
										OR ORANGE DICHROIC	

ORDERING GUIDE EXAMPLE:
 Oscar / 4 / Round / Trim / White / Recessed Gimbal / Chrome / 26W / 2700K / 15° Beam Angle / Clear Diffuser
CODE: OSC-4-R-T-02-RG-04-26-27-N-CL

REFLECTOR OPTIONS

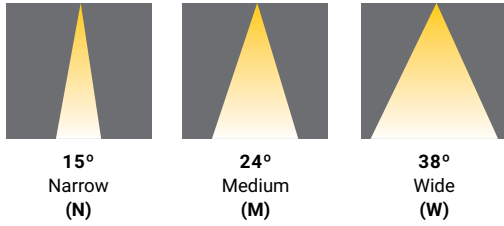

BAFFLE FINISHES

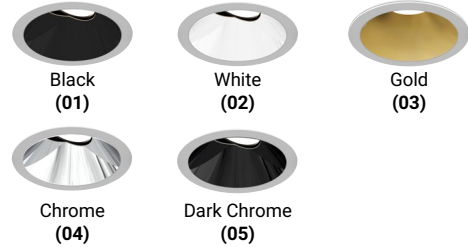

DIFFUSER OPTIONS

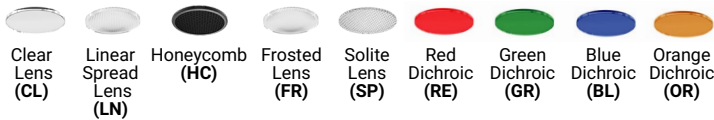

ADD-ONS

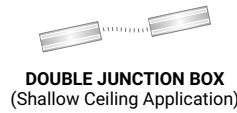

NEW CONSTRUCTION PLATES + IC BOXES



NEW CONSTRUCTION PLATE
TRIM/TRIMLESS
43786-015

CUT HOLE:
Trim & Trimless: Ø4"

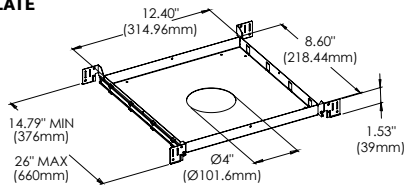

TRIM
AT/IC Box: 44300-026
IC Box: 44300-012

CUT HOLE:
Trim & Trimless: Ø4"

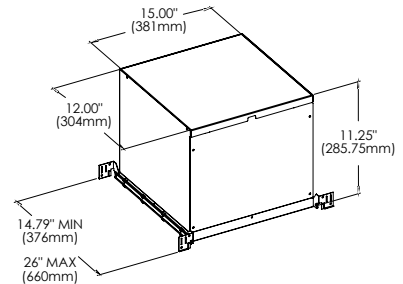

DRIVERS

- Compatible with TRIAC (forward-phase or leading-edge) ELV (reverse-phase or trailing edge) and 0-10V dimmers.
- ESSxxxW models: TRIAC and ELV dimming only at 120 Vac
- ESSxxxW models: ELV dimming only at 230 Vac
- 90° C maximum case hot spot temperature
- Class 2 power supply
- Lifetime: 50,000 hours at 70° case hot spot temperature (some models have a higher lifetime)
- IP64-rated (IP66 for ESST) case with silicone-based potting
- Protections: Output open load, over-current and short-circuit (hiccup), and over-temperature with auto recovery.
- Conducted and radiated EMI: Compliant with FCC CFR Title 47 Part 15 Class B (120 Vac) and Class A (277 Vac), and EN55015 (CISPR 15) at 220, 230, and 240 Vac.
- Complies with ENERGY STAR®, DLC (DesignLight Consortium®) and CA Title 24 technical requirements
- Worldwide safety approvals

