

FOCUS



Fase¹_{TM}

CHARLIE
FOCUS





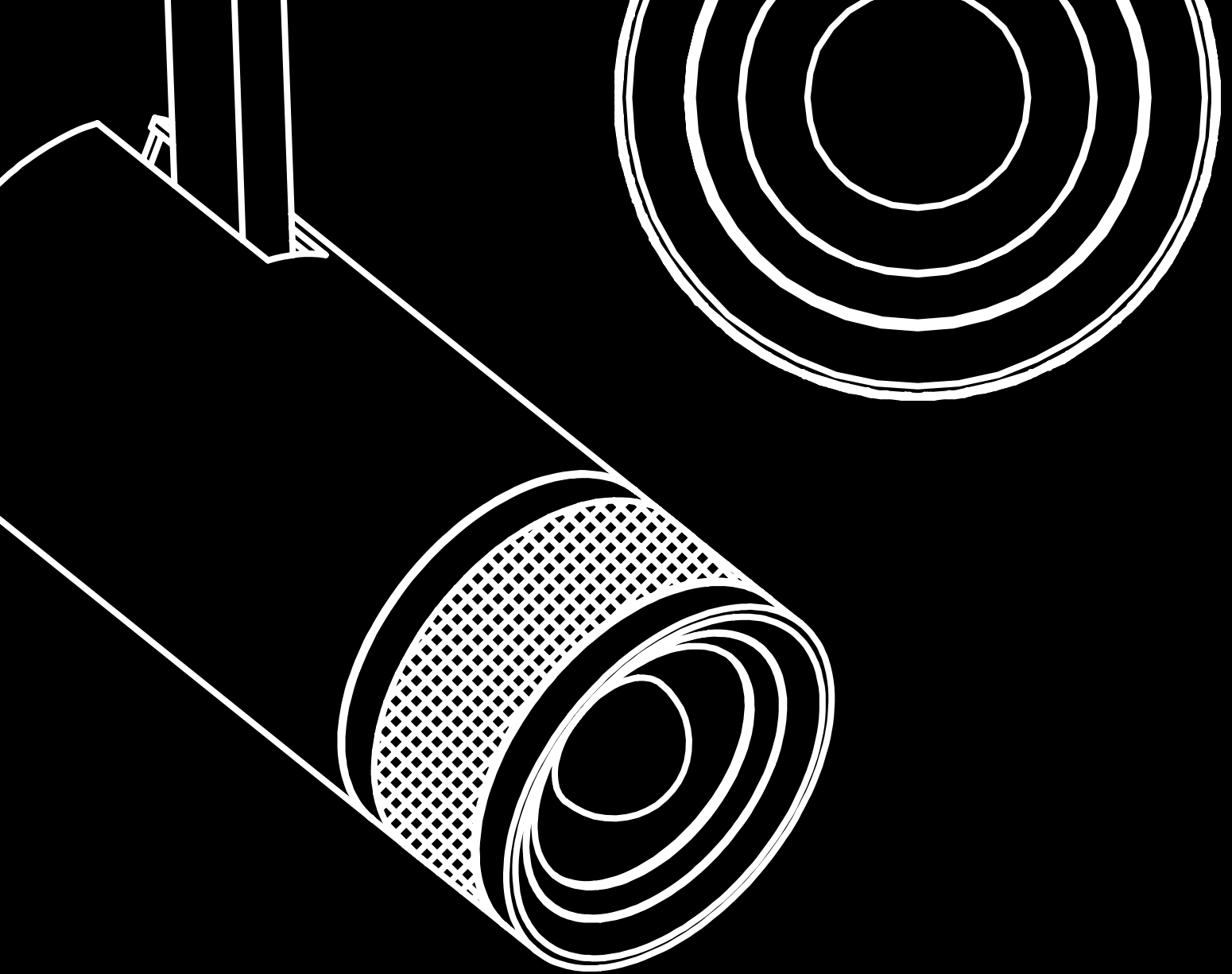

FOCUS

Introducing

THE FOCUS

Focus stays true to the conventional style of track lighting and incorporates simplistic, modern style. Made out of 1070 pure aluminum, it is built to last with durable strength like no other. A special machined rotating front bezel feature controls beam spread from its double bifocal lenses. This allows the beam to change from 15° to 55° with maximum uniformity.

Available in both a matte black and white finish, the Focus collection will easily match a variety of décor for consistent style. Allow us to help you focus on what truly matters in life.

Aperture Adjustability

Vertical Rotation: 90°

Horizontal Rotation 350°



SPOT

The spot module is the best choice for directional lighting to highlight specific pieces that deserve that extra attention. Each movement is decisive with discreet luxury, detail is essential. Specific to the Focus collection is a field adjustable aperture ring which controls the beam angle, zooming and focusing it between 20° - 55°, 15° - 45° functioning similarly to that found on a DSLR camera.

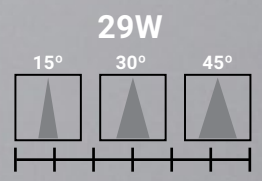
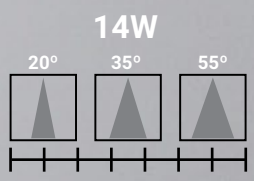



14W

39713

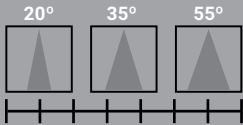

Available in white or black

LAMPING

Model Number: 39713
Light Source: 14W Integrated LED
Beam Angle: 20°- 55° adjustable
Vertical Rotation: 90°
Horizontal Rotation: 350°
Kelvin: 3000K/3500K
Lumens: 820-1120lm
CRI: 90+
Dimming: TRIAC
Color: Black/White
Input: 120V

| MODEL | KELVIN | FINISH |
|-------|-----------|-----------|
| 39713 | -30 3000K | -01 Black |
| | -35 3500K | -02 White |

EXAMPLE: 39713-30-02

OPTIONAL ACCESSORY



HONEY COMB LOUVER

| FINISH | ITEM NUMBER |
|--------|--------------|
| BLACK | 39757-01-018 |
| WHITE | 39757-02-018 |

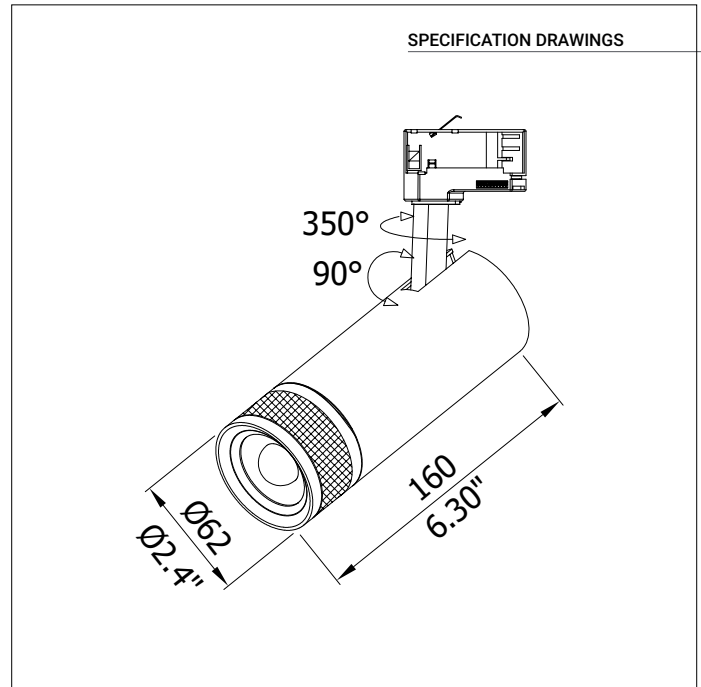



29W

39714

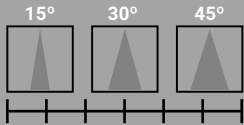

Available in white or black

LAMPING

| | |
|----------------------|---------------------|
| Model Number: | 39714 |
| Light Source: | 29W Integrated LED |
| Beam Angle: | 15°- 45° adjustable |
| Vertical Rotation: | 90° |
| Horizontal Rotation: | 350° |
| Kelvin: | 3000K/3500K |
| Lumens: | 1655-2165lm |
| CRI: | 90+ |
| Dimming: | TRIAC |
| Color: | Black/White |
| Input: | 120V |

| MODEL | KELVIN | FINISH |
|-------|-----------|-----------|
| 39714 | -30 3000K | -01 Black |
| | -35 3500K | -02 White |

EXAMPLE: 39714-30-02

OPTIONAL ACCESSORY



HONEY COMB LOUVER

| FINISH | ITEM NUMBER |
|--------|--------------|
| BLACK | 39758-01-018 |
| WHITE | 39758-02-018 |

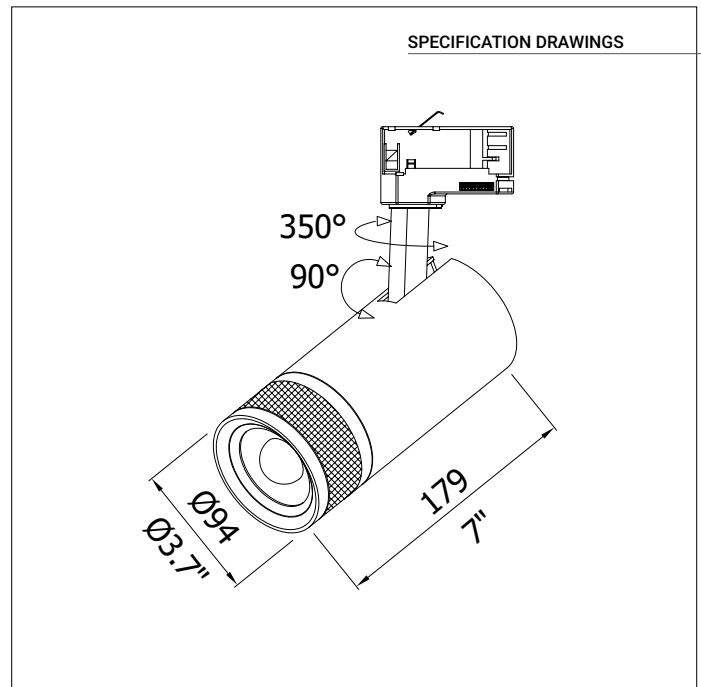

** See pg 19 for full photometrics

*** For customization, please consult Eurofase



ACCESSORIES

MODULAR TRACK

- Versatile and adaptable, modular lighting allows you to configure a lighting scheme that is custom configured to your needs
- Feature all adjustability for aiming in any direction
- Field-cutable track sections are combined with feeds and joiners making virtually any configuration possible

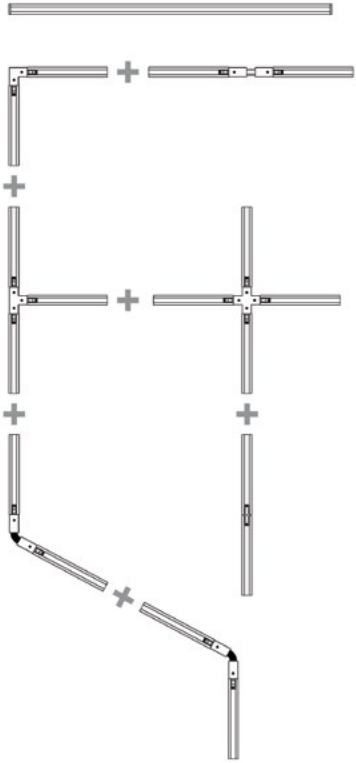

TRACK

- Single circuit track, 3-conductor, 20A maximum per circuit
- Can be surface mounted on walls or ceilings
- Field cuttable to desired length
- Use components to build any desired configuration
- Includes 2 dead-end covers

1002 2-FOOT TRACK



1004 4-FOOT TRACK



1008 8-FOOT TRACK



-01 Black

-02 White



FLOATING CANOPY

- Mounts on any point along the track
- Feeds power and covers outlet box

ITEM# FINISHES
1615 -01 ● -02 ○

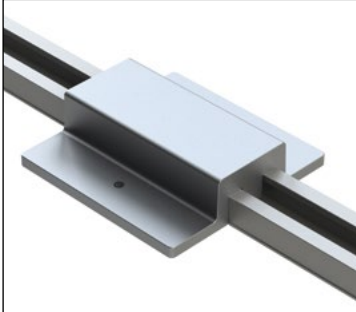

MINI CONNECTOR

- Joins two tracks mechanically and electrically
- Power cannot be fed

ITEM# FINISHES
1560 -01 ● -02 ○



T CONNECTOR

- For joining three tracks in "T" configuration and feeding power
- Allows independent feed or same circuit.
- Polarized and pre-wired

ITEM# FINISHES
1540 -01 ● -02 ○

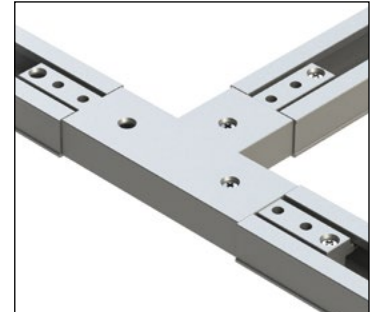

LIVE END CONNECTOR

- For feeding track mounted flush to surface without outlet box or canopy

ITEM# FINISHES
1510 -01 ● -02 ○



FLEXIBLE CONNECTOR

- For joining two tracks in a variable angle 0 to 90 degrees and feeding power

ITEM# FINISHES
1570 -01 ● -02 ○

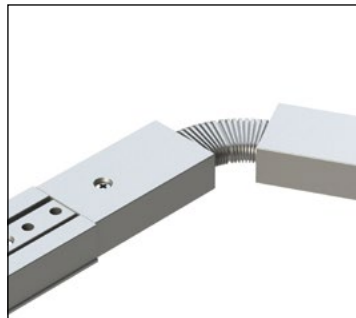

X CONNECTOR

- For joining three tracks in an "X" configuration and feeding power
- Allows independent feed or same circuit
- Polarized and pre-wired

ITEM# FINISHES
1550 -01 ● -02 ○

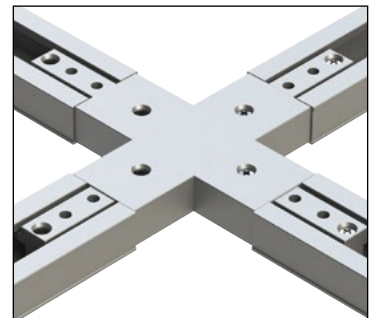

LIVE END CONDUIT

- Use with appropriate electrical conduit connector to feed power at track end
- Can be fed from the back or top

ITEM# FINISHES
1617 -01 ● -02 ○



L CONNECTOR

- For joining two tracks at a 90 degree angle and feeding power
- Allows independent feed or same circuit
- Polarized and pre-wired

ITEM# FINISHES
1530 -01 ● -02 ○



INSTALLATION GUIDE

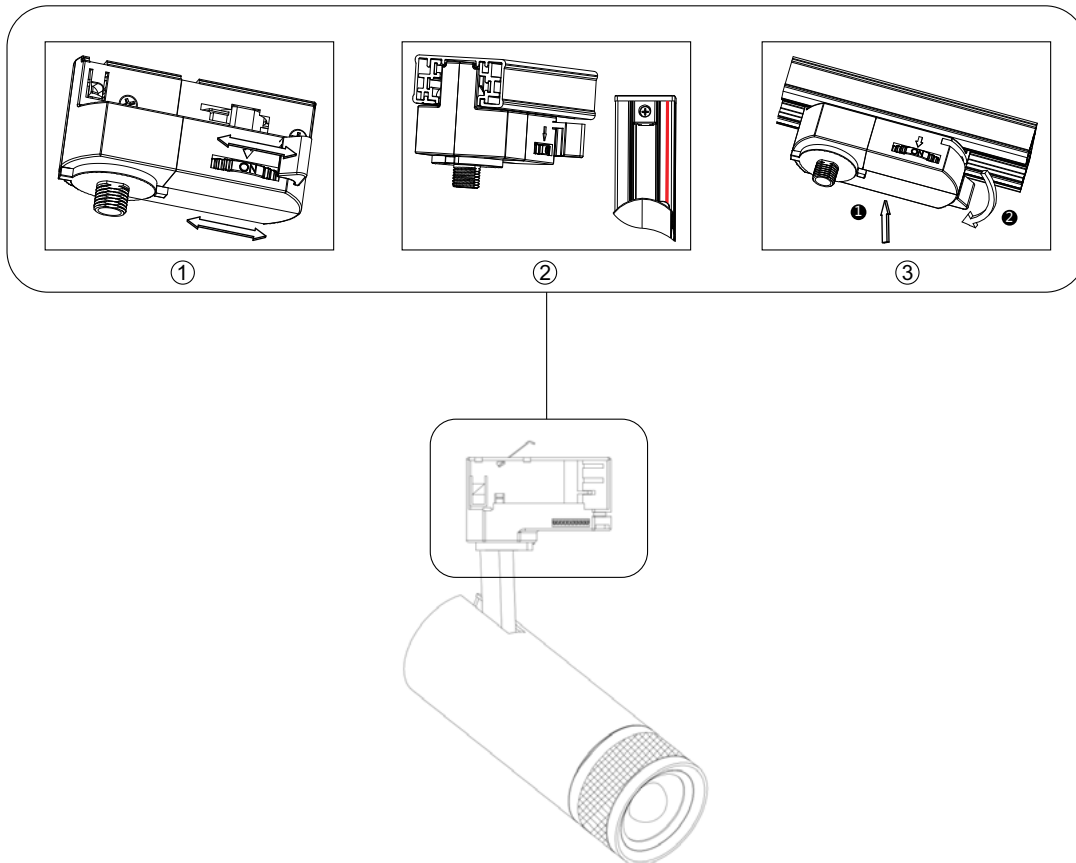

14W/29W, 120V 60Hz, (Dimmable LED driver included)

PHOTOMETRICS

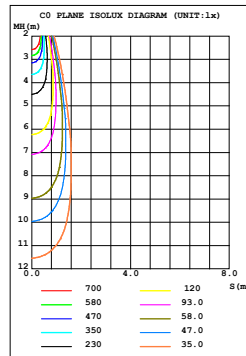
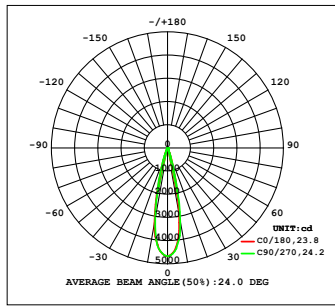

14W - 3000K - 20°

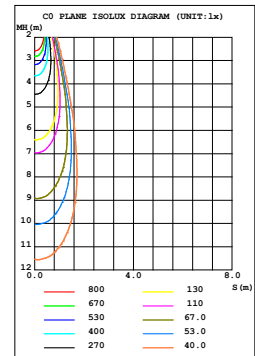
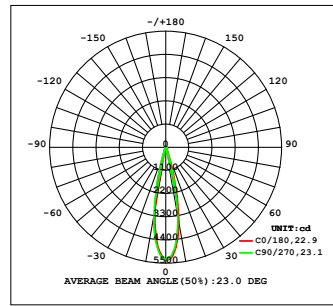

14W - 3500K - 20°

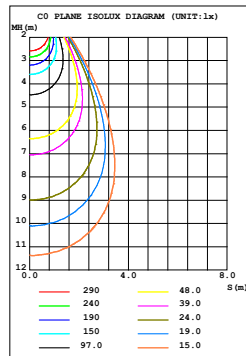
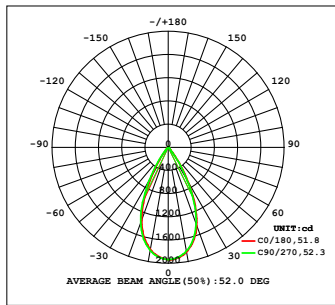

14W - 3000K - 55°

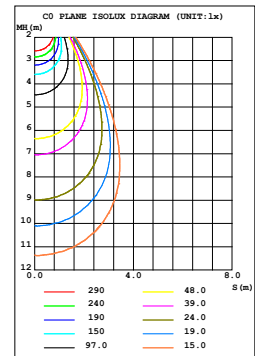
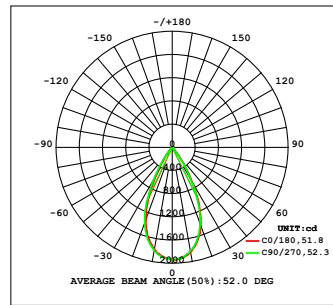

14W - 3500K - 55°

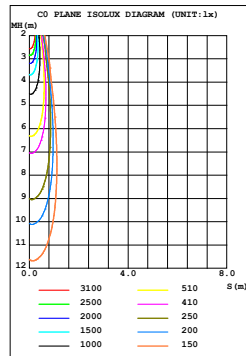
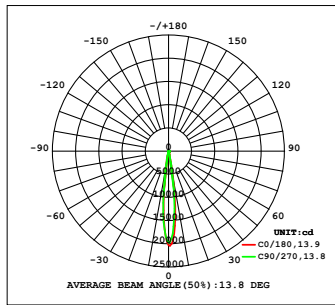

29W - 3000K - 15°

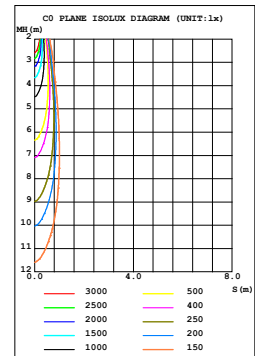
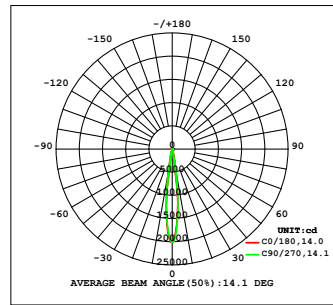

29W - 3500K - 15°

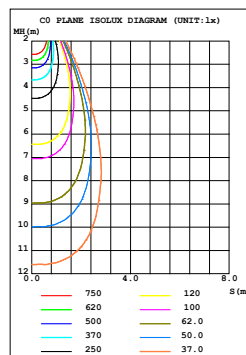
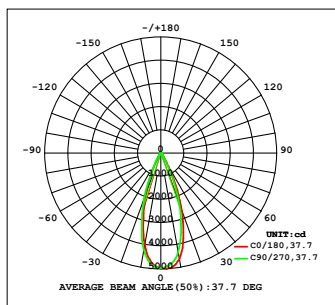

29W - 3000K - 45°

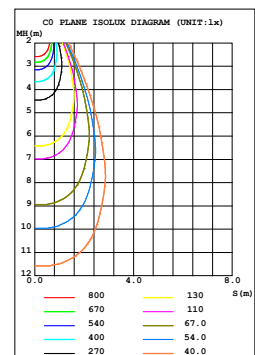
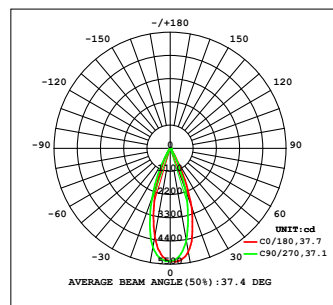

29W - 3500K - 45°

LASTING IMPRESSION

The Focus collection are ETL Listed to ensure safe operation for many years to come. We want to ensure your success with every project you tackle. We're also offering a 5 year limited warranty.





Fase¹

33 West Beaver Creek Road,
Richmond Hill, Ontario Canada L4B 1L8

tel 905.695.2055
fax 905.695.2056

toll free 1.800.660.5391
toll free 1.800.660.5390

DALLAS TRADE MART
Eurofase Showroom, Suite #4002



Printed in Canada
© 2021 Eurofase Inc. All rights reserved.

Eurofase Inc. reserves the right to make alterations to the construction and design of products shown in this catalog in order to meet the laws or regulations of any authorized governing organization. The use of products shown in this catalog must comply with local building codes.